

ISIER

REZİSTANS

Tüm Rezistans İhtiyaçlarınızda
Çözüm Ortağınız.

ÜRÜN KATALOĞU



www.isierrezistans.com

10+ YILLIK TECRÜBE

HAKKIMIZDA

Farklı müşteriler için onların ihtiyaçlarına uygun endüstriyel rezistans çözümleri üreten, müşterisine en kaliteli hizmeti sağlamayı kendisine ilke edinen, kendisini tercih edenlere değer oluşturmayı ilke edinmiş ve sadece müşteri memnuniyetini ön planda tutan, hızla değişen teknolojiyi takip ederek gelecekteki olası değişimleri araştıran, bunları önceden belirleyerek gerekli değişiklikleri hızla uygulayan Isier Rezistans; satışını gerçekleştirdiği rezistans ve ısı kontrol cihazları ile sektöründe hızla zirveye yürümektedir.

Üreticisi ve ithalatçısı olduğu yüksek kaliteli tüm ürünlerini müşteri memnuniyeti odaklı çalışmalar ve zamanında teslimat prensipleriyle müşterilerine sunan, kurulduğu ilk günden bugüne sürekli kendini yenileyerek büyüyen Isier Rezistans, Türkiye ve dünya genelindeki müşterilerine kusursuz hizmet sunmaya

Türkiye'nin En Büyük Rezistans Üreticisi

MİSYONUMUZ

İleri teknikleri ve son teknolojileri kullanarak ve Ar-Ge çalışmalarımızı sürekli arttırarak; dünya pazarlarında kabul gören en yüksek standartlara sahip kaliteli ürünlerimizle uluslar arası bir marka olmak.



VİZYONUMUZ

Uzun yıllara dayanan tecrübemizle kurumsal değerlerimizi koruyarak rekabet ortamında da en iyi hizmeti ve en kaliteli ürünleri yeni teknolojilerle donatılmış tesisimizde, tecrübeli ve çalışanlarımız ile birlikte ülkesine ve değer katan, sektöründe takip edilen firma olabilmektir.



KALİTELİ VE UZMAN KADRO

Rezistans imalatlarımız profesyonel teknik personellerimiz tarafından üretilmektedir. Doğru akım, doğru enerji mantığı ile ısıyı en doğru şekilde yayılmasını sağlıyor, bu sayede endüstriyel makinelerinizin ömrünü uzatıyoruz.

YÜKSEK KALİTELİ ÜRÜNLER

Isier Rezistans olarak; Üretimlerini gerçekleştirdiğimiz rezistanslarda kullandığımız tüm malzemeler A kalite ürünlerden oluşmaktadır. Bu sayede herhangi bir bozulma veya kırılma yaşanmadan uzun yıllar gönül rahatlığı ile kullanabilirsiniz.

İÇİNDEKİLER

Semaver Rezistanslar
Semovar Heaters

1-5

Endüstriyel Grup Rezistanslar
Industrial Group Heaters

6-14

Pirinç Rezistanslar
Brass Head Heaters

14-19

Çamaşır Makinesi Rezistansları
Washing Machine Heaters

20-21

Termosifon - Şofben Rezistansları
Thermosiffon Geyser Heaters

22-24

Tost Rezistansları
Toast Heaters

25-27

Fırın Rezistansları
Oven Heaters

28-32

Çubuk Rezistanslar
Rod Heaters

33

Havalandırma Rezistansları
Ventilation Heaters

34-36

Fişek Rezistanslar
Cartridge Heaters

37

Spiral Rezistanslar
Spiral Heaters

38

Kelepçe Rezistanslar
Clamp Heaters

39

Meme Rezistanslar
Nozzle Heaters

40

Plaka Rezistanslar
Mica Heaters

41

Flanşlı ve Exproof Rezistanslar
Flanged And Exproof Heaters

42

Quartz Rezistanslar
Quartz Heaters

43

Balon Isıtıcılar
Chemical Baloon Heaters

43

Manifold Rezistanslar
Manifold Heaters

44

Termokupl
Thermocouple

45

Nozzle / Sıcak Yolluk Memeleri
Nozzle / Hot Runner Nozzles

46-54

Sıcak Yolluk Ünitesi
Hot Runner Control Unit

55

SEMAVER REZİSTANSLAR

SAMOVAR HEATERS



SEMAVER REZİSTANSLARI			SAMOVAR HEATERS		
ÜRÜN KODU	VOLT	WATT	BORU ÇAPI (Ø)	(AISI)	ÖLÇÜ / MM
SM0001	230 V	1000 W	8,5	304	A:91 B:40 C:125
SM0005	230 V	1000 W	6,5	304	A:91 B:40 C:125



SEMAVER REZİSTANSLARI			SAMOVAR HEATERS		
ÜRÜN KODU	VOLT	WATT	BORU ÇAPI (Ø)	(AISI)	ÖLÇÜ / MM
SM0002	230 V	1500 W	8,5	304	A:146 B:40 C:125
SM0006	230 V	1500 W	6,5	304	A:149 B:40 C:118



SEMAVER REZİSTANSLARI			SAMOVAR HEATERS		
ÜRÜN KODU	VOLT	WATT	BORU ÇAPI (Ø)	(AISI)	ÖLÇÜ / MM
SM0003	230 V	2000 W	8,5	304	A:138 B:40 C:160
SM0007	230 V	2000 W	6,5	304	A:149 B:40 C:165

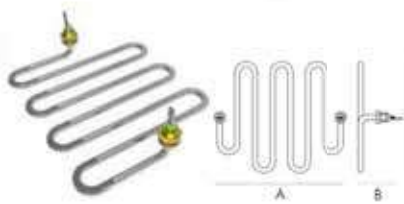

SEMAVER REZİSTANSLARI			SAMOVAR HEATERS		
ÜRÜN KODU	VOLT	WATT	BORU ÇAPI (Ø)	(AISI)	ÖLÇÜ / MM
SM0004	230 V	2500 W	8,5	304	A:200,5 B:45 C:173,5
SM0008	230 V	2500 W	6,5	304	A:206 B:40 C:170



SEMAVER REZİSTANSI			SAMOVAR HEATER		
ÜRÜN KODU	VOLT	WATT	BORU ÇAPI (Ø)	(AISI)	ÖLÇÜ / MM
SM0009	230 V	1200 W	6,5	304	A:155 B:140 B1:33,5



KARE TEKNOGRAD SEMAVER REZİSTANS SQUARE TECHNOGRAD SAMOVAR HEATER

ÜRÜN KODU	VOLT	WATT	BORU ÇAPI (Ø)	(AISI)	ÖLÇÜ / MM
SM0010	230V	1700 W	6,5	304	A:175 B:200



KARE TEKNOGRAD SEMAVER REZİSTANS SQUARE TECHNOGRAD SAMOVAR HEATER

ÜRÜN KODU	VOLT	WATT	BORU ÇAPI (Ø)	(AISI)	ÖLÇÜ / MM
SM0011	230V	2200 W	6,5	304	A:220 B:245

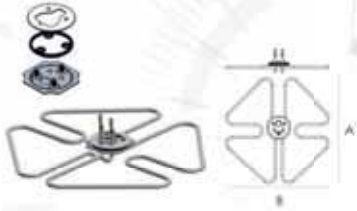

KARE TEKNOGRAD SEMAVER REZİSTANS SQUARE TECHNOGRAD SAMOVAR HEATER

ÜRÜN KODU	VOLT	WATT	BORU ÇAPI (Ø)	(AISI)	ÖLÇÜ / MM
SM0012	230V	2750 W	6,5	304	A:310 B:310

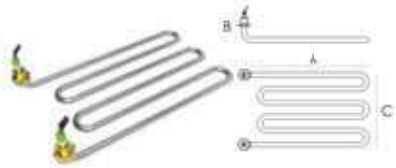

M TİPİ SEMAVER REZİSTANSLAR M TYPE SAMOVAR HEATERS

ÜRÜN KODU	VOLT	WATT	BORU ÇAPI (Ø)	(AISI)	ÖLÇÜ / MM
SM0013	230V	2000 W	8,5	304	A:232 B:44 C:133,5
SM0014	230V	1500 W	8,5	304	A:15 B:15
SM0015	230V	1800 W	8,5	304	A:18 B:15



SEMAVER REZİSTANSI SAMOVAR HEATER

ÜRÜN KODU	VOLT	WATT	BORU ÇAPI (Ø)	(AISI)	ÖLÇÜ / MM
SM0016	230V	2000 W	8,5	304	A:260 B:133,5

SEMAVER REZİSTANSLAR

SAMOVAR HEATERS

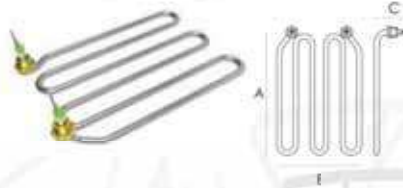

M TİPİ SEMAVER REZİSTANS

M TYPE SAMOVAR HEATER

ÜRÜN KODU	VOLT	WATT	BORU ÇAPI (Ø)	(AISI)	ÖLÇÜ / MM
SM0017	230V	2000 W	8,5	304	A:215 B:148 C:42,5



M TİPİ SEMAVER REZİSTANS

M TYPE SAMOVAR HEATER

ÜRÜN KODU	VOLT	WATT	BORU ÇAPI (Ø)	(AISI)	ÖLÇÜ / MM
SM0018	230V	2000 W	8,5	304	A:253 B:140

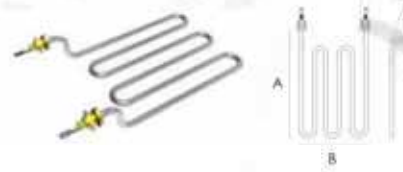

M TİPİ SEMAVER REZİSTANS

M TYPE SAMOVAR HEATER

ÜRÜN KODU	VOLT	WATT	BORU ÇAPI (Ø)	(AISI)	ÖLÇÜ / MM
SM0019	230V	2000 W	8,5	304	A:242 B:145 C:48

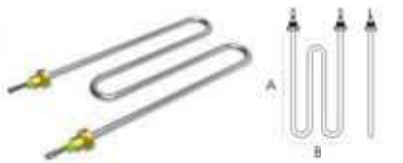

M TİPİ SEMAVER REZİSTANS

M TYPE SAMOVAR HEATER

ÜRÜN KODU	VOLT	WATT	BORU ÇAPI (Ø)	(AISI)	ÖLÇÜ / MM
SM0020	230V	1900 W	8,5	304	A:212 B:100



M TİPİ SEMAVER REZİSTANS

M TYPE SAMOVAR HEATER

ÜRÜN KODU	VOLT	WATT	BORU ÇAPI (Ø)	(AISI)	ÖLÇÜ / MM
SM0021	230V	2000 W	8,5	304	A:236 B:120 B1:41



M TİPİ SEMAVER REZİSTANS

M TYPE SAMOVAR HEATER

ÜRÜN KODU	VOLT	WATT	BORU		ÖLÇÜ / MM
			ÇAPI (Ø)	(AISI)	
SM0022	230V	2500 W	8,1	304	A:330 B:154 C:72



REKÖRLÜ KROM FILETE REZİSTANS

RECORDED CHROME FILETTE HEATER

ÜRÜN KODU	VOLT	WATT	BORU		ÖLÇÜ / MM
			ÇAPI (Ø)	(AISI)	
SM0023	230V	2000 W	8,1	304	A:280 B:30



REKÖRLÜ KROM SİPİRLİ REZİSTANSLAR

RECORDED CHROME SPIRAL HEATERS

ÜRÜN KODU	VOLT	WATT	BORU		ÖLÇÜ / MM
			ÇAPI (Ø)	(AISI)	
SM0025	230V	2000 W	6,5	304	A:140 B:62
SM0024	230V	2000 W	6,5	304	A:141 B:61



SEMAVER REZİSTANSI

SAMOVAR HEATER

ÜRÜN KODU	VOLT	WATT	BORU		ÖLÇÜ / MM
			ÇAPI (Ø)	(AISI)	
SM0026	230V	1250 W	8,5	304	A:140 B:142 C:40



FIRIN TURBO FAN REZİSTANSI

OVEN TURBO FAN HEATER

ÜRÜN KODU	VOLT	WATT	BORU		ÖLÇÜ / MM
			ÇAPI (Ø)	(AISI)	
SM0027	230V	1500 W	8,5	304	A:263 B:40 C:122

SEMAVER REZİSTANSLAR

SAMOVAR HEATERS



BÜYÜK ÇAYDANLIK REZİSTANSI

LARGE TEAPOT HEATER

ÜRÜN KODU	VOLT	WATT	BORU		ÖLÇÜ / MM
			ÇAPI (Ø)	(AISI)	
SM0028	230V	650 W	8,5	304	A:75 B:70 C:35



SEMAVER REZİSTANSLARI

SAMOVAR HEATERS

ÜRÜN KODU	VOLT	WATT	BORU		ÖLÇÜ / MM
			ÇAPI (Ø)	(AISI)	
SM0029	230V	800 W	8,5	304	A:130 B:125 C:35
SM0030	230V	800 W	8,3	BAKIR	A:130 B:125 C:35



ÇAYDANLIK REZİSTANSI

TEAPOT HEATER

ÜRÜN KODU	VOLT	WATT	BORU		ÖLÇÜ / MM
			ÇAPI (Ø)	(AISI)	
SM0031	230V	800 W	6,5	304	A:110 B:100 C:40



SEMAVER REZİSTANSLARI

SAMOVAR HEATERS

ÜRÜN KODU	VOLT	WATT	BORU		ÖLÇÜ / MM
			ÇAPI (Ø)	(AISI)	
SM0032	230V	2000 W	6,5	304	A:100 B:96,5 C:30
SM0033	230V	1100 W	6,5	304	A:100 B:96,5 C:30

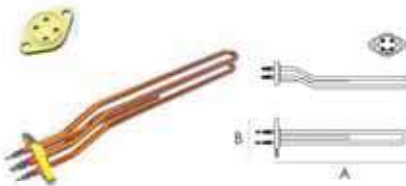

ÜÇGEN FLANŞLI BAKIR KAHVE REZİSTANSLARI

TRIANGLE FLANGE COPPER COFFEE HEATERS

ÜRÜN KODU	VOLT	WATT	BORU		ÖLÇÜ / MM
			ÇAPI (Ø)	(AISI)	
SM0034	230V	3500 W	8,3	BAKIR	A:335 B:95
SM0035	230V	4500 W	8,3	BAKIR	A:520 B:95



U TİPİ BENMARİ REZİSTANSLAR

U TYPE PIPE HEATERS

ÜRÜN KODU	VOLT	WATT	BORU ÇAPI (Ø)	(AISI)	ÖLÇÜ / MM
BMU003-D	230 V	1000 W	8,5	304	A:300 B:100
BMU004-D	230 V	1500 W	8,5	304	A:400 B:100
BMU005-D	230 V	2000 W	8,5	304	A:500 B:100
BMU006-D	230 V	2000 W	8,5	304	A:600 B:100
BMU007-D	230 V	2250 W	8,5	304	A:700 B:100
BMU008-D	230 V	2500 W	8,5	304	A:800 B:100
BMU009-D	230 V	2500 W	8,5	304	A:900 B:100
BMU010-D	230 V	2500 W	8,5	304	A:1000 B:100
BMU011-D	230 V	2500 W	8,5	304	A:1100 B:100



U TİPİ BENMARİ REZİSTANSLAR

U TYPE PIPE HEATERS

ÜRÜN KODU	VOLT	WATT	BORU ÇAPI (Ø)	(AISI)	ÖLÇÜ / MM
BMU003-E	230 V	1000 W	8,5	304	A:300 B:100 C:40
BMU004-E	230 V	1500 W	8,5	304	A:400 B:100 C:40
BMU005-E	230 V	2000 W	8,5	304	A:500 B:100 C:40
BMU006-E	230 V	2000 W	8,5	304	A:600 B:100 C:40
BMU007-E	230 V	2250 W	8,5	304	A:700 B:100 C:40
BMU008-E	230 V	2500 W	8,5	304	A:800 B:100 C:40
BMU009-E	230 V	2500 W	8,5	304	A:900 B:100 C:40
BMU010-E	230 V	2500 W	8,5	304	A:1000 B:100 C:40
BMU011-E	230 V	2500 W	8,5	304	A:1100 B:100 C:40



M TİPİ BENMARİ REZİSTANSLAR

M TYPE PIPE HEATERS

ÜRÜN KODU	VOLT	WATT	BORU ÇAPI (Ø)	(AISI)	ÖLÇÜ / MM
BM0001	230 V	2000 W	8,5	304	A:300 B:210
BM0002	230 V	2000 W	8,5	304	A:400 B:210
BM0003	230 V	2500 W	8,5	304	A:500 B:210

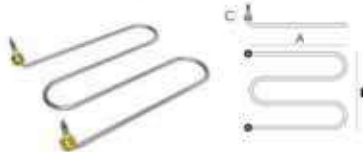

M TİPİ BENMARİ REZİSTANSLAR

M TYPE PIPE HEATERS

ÜRÜN KODU	VOLT	WATT	BORU ÇAPI (Ø)	(AISI)	ÖLÇÜ / MM
BM0001E	230 V	2000 W	8,5	304	A:300 B:210 C:44
BM0002E	230 V	2000 W	8,5	304	A:400 B:200 C:40
BM0003E	230 V	2500 W	8,3	304	A:500 B:210

ENDÜSTRİYEL GRUP REZİSTANSLARI

INDUSTRIAL GROUP HEATERS

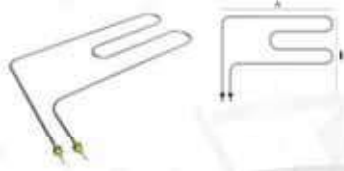

BARBEKÜ REZİSTANSI

BARBECUE HEATER

ÜRÜN KODU	VOLT	WATT	BORU ÇAP (Ø)	(AISI)	ÖLÇÜ / MM
BM0004	230V	2500 W	8,5	304	A:565 B:385

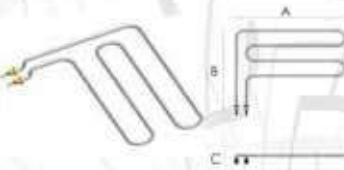

ENDÜSTRİYEL BENMARI REZİSTANS

INDUSTRIAL PIPE HEATER

ÜRÜN KODU	VOLT	WATT	BORU ÇAP (Ø)	(AISI)	ÖLÇÜ / MM
BM0005	230V	3000 W	8,5	304	A:568 B:375 C:28

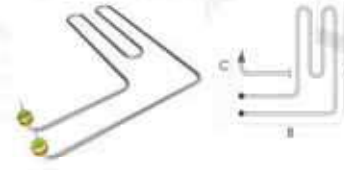

ENDÜSTRİYEL BENMARI REZİSTANS

INDUSTRIAL PIPE HEATER

ÜRÜN KODU	VOLT	WATT	BORU ÇAP (Ø)	(AISI)	ÖLÇÜ / MM
BM0006	230V	2500 W	8,5	304	A:350 B:320 C:55

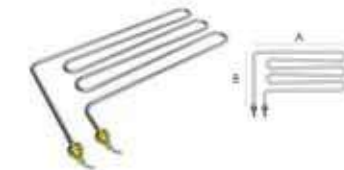

ENDÜSTRİYEL BENMARI REZİSTANSLAR

INDUSTRIAL PIPE HEATERS

ÜRÜN KODU	VOLT	WATT	BORU ÇAP (Ø)	(AISI)	ÖLÇÜ / MM
BM0007	230V	1500 W	8,5	304	A:355 B:224,5



ÇİFT FIRIN REZİSTANSLARI

DOUBLE OVEN HEATERS

ÜRÜN KODU	VOLT	WATT	BORU ÇAP (Ø)	(AISI)	ÖLÇÜ / MM
ÜBMB0001	230 V	4500 W	8,5	304	A:300 B:83
ÜBMB0002	230V	6000 W	8,5	304	A:350 B:83
ÜBMB0003	230 V	7500 W	8,5	304	A:350 B:83
ÜBMB0004	230 V	9000 W	8,5	304	A:400 B:83
ÜBMB0005	230 V	10000 W	8,5	304	A:400 B:83
ÜBMB0001	230-380V	4500 W	8,5	304	A:300 B:45
ÜBMB0002	230-380V	6000 W	8,5	304	A:350 B:45
ÜBMB0003	230-380V	7500 W	8,5	304	A:350 B:45
ÜBMB0004	230-380V	10000 W	8,5	304	A:400 B:45



ENDÜSTRİYEL GRUP REZİSTANSLARI

INDUSTRIAL GROUP HEATERS



ENDÜSTRİYEL MUTFAK REZİSTANSLARI

INDUSTRIAL KITCHEN HEATERS

ÜRÜN KODU	VOLT	WATT	BORU		ÖLÇÜ / MM
			ÇAPI (Ø)	(AISI)	
ÜBM80005	230-380V	3X3000 W	6,5	304	A:300 B:45
ÜBM80005	230-380V	3X3000 W	8,3	304	A:350 B:45



MİNİK ÜÇGEN REZİSTANSLAR

TINY TRIANGLE HEATERS

ÜRÜN KODU	VOLT	WATT	BORU		ÖLÇÜ / MM
			ÇAPI (Ø)	(AISI)	
ÜBM006	230V	2000 W	6,5	304	A:200 B:67
ÜBM007	230V	3000 W	6,5	304	A:335 B:67



BÜYÜK ÜÇGEN FLANŞLI REZİSTANS

LARGE TRIANGLE FLANGE HEATER

ÜRÜN KODU	VOLT	WATT	BORU		ÖLÇÜ / MM
			ÇAPI (Ø)	(AISI)	
ÜBM008	230V	3000 W	6,5	304	A:327 B:83,5



ÜÇGEN FLANŞLI REZİSTANS

TRIANGLE FLANGE HEATER

ÜRÜN KODU	VOLT	WATT	BORU		ÖLÇÜ / MM
			ÇAPI (Ø)	(AISI)	
ÜBM009	230V	2800 W	8,3	304	A:350 B:26



ÇAMAŞIR MAKİNESİ REZİSTANSI

WASHING MACHINE HEATER

ÜRÜN KODU	VOLT	WATT	BORU		ÖLÇÜ / MM
			ÇAPI (Ø)	(AISI)	
ÜBM80006	230-380V	4500 W	8,5	304	A:320 B:40

ENDÜSTRİYEL GRUP REZİSTANSLARI

INDUSTRIAL GROUP HEATERS



ENDÜSTRİYEL MUTFAK REZİSTANSI

INDUSTRIAL KITCHEN HEATER

ÜRÜN KODU	VOLT	WATT	BORU ÇAPI (Ø)		ÖLÇÜ / MM
			(AISI)		
ED0001	230V	3000 W	8,5	304	A:245 B:55



TANK REZİSTANSLARI

TANK HEATERS

ÜRÜN KODU	VOLT	WATT	BORU ÇAPI (Ø)		ÖLÇÜ / MM
			(AISI)		
ED0002	230V	2800 W	8,3	304	A:370 B:90 C:50
ED0003	230V	2000 W	8,3	304	A:290 B:98 C:55



ENDÜSTRİYEL DALDIRMA TİPİ REZİSTANSLAR

INDUSTRIAL IMMERSION TYPE RESISTANCES

ÜRÜN KODU	VOLT	WATT	BORU ÇAPI (Ø)		ÖLÇÜ / MM
			(AISI)		
ED0004	230V	3X2000 W	8,5	304	A:410 B:82,5
ED0005	230-380 V	3X3333 W	8,5	304	A:410 B:82,5



REKÖRLÜ BAKIR FİLKETE REZİSTANSLAR

RECORD BREAKING COPPER FILE HEATERS

ÜRÜN KODU	VOLT	WATT	BORU ÇAPI (Ø)		ÖLÇÜ / MM
			(AISI)		
ED0006	230V	800 W	8,3	BAKIR	A:286 B:50 C:45

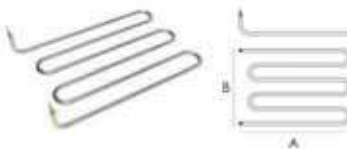

ENDÜSTRİYEL MUTFAK REZİSTANSI

INDUSTRIAL KITCHEN HEATER

ÜRÜN KODU	VOLT	WATT	BORU ÇAPI (Ø)		ÖLÇÜ / MM
			(AISI)		
ED0007	230V	1900 W	8,5	304	A:315 B:210



ENDÜSTRİYEL GRUP REZİSTANSLARI

INDUSTRIAL GROUP HEATERS



ENDÜSTRİYEL MUTFAK REZİSTANSI

INDUSTRIAL KITCHEN HEATER

ÜRÜN KODU	VOLT	WATT	BORU ÇAP (Ø)	(AISI)	ÖLÇÜ / MM
ED0008	230V	2500 W	8,5	304	A:372 B:91,5 C:38



KAZAN REZİSTANSI

BOILER HEATER

ÜRÜN KODU	VOLT	WATT	BORU ÇAP (Ø)	(AISI)	ÖLÇÜ / MM
ED0009	230V	3X1500 W	6,5	304	A:360 B:65



ÇİFTLİ ÇAMAŞIR MAKİNESİ REZİSTANSLAR

DOUBLE WASHING MACHINE HEATERS

ÜRÜN KODU	VOLT	WATT	BORU ÇAP (Ø)	(AISI)	ÖLÇÜ / MM
ED0010	230V	1800+1800 W	8,5	304	A:300 B:80
ED0011	230V	2000+2000 W	8,5	304	A:400 B:80



ÇAMAŞIR MAKİNESİ REZİSTANSI

WASHING MACHINE HEATER

ÜRÜN KODU	VOLT	WATT	BORU ÇAP (Ø)	(AISI)	ÖLÇÜ / MM
ED0012	230V	1000 W	8,5	304	A:285 B:80 C:52



REKORLU BAINMARİ REZİSTANSLAR

RECORDED BAINMARIE HEATERS

ÜRÜN KODU	VOLT	WATT	BORU ÇAP (Ø)	(AISI)	ÖLÇÜ / MM
ED0013	230V	2500 W	8,5	304	A:440 B:54
ED0014	230V	2500 W	8,5	304	A:500 B:54

ENDÜSTRİYEL GRUP REZİSTANSLARI

INDUSTRIAL GROUP HEATERS



TANK REZİSTANSI

TANK HEATERS

ÜRÜN KODU	VOLT	WATT	BORU ÇAP (Ø)	(AISI)	ÖLÇÜ / MM
ED0015	230V	3000 W	8,3	304	A:470 B:65 C:50



2" TRİFAZE REZİSTANS

2" THREE PHASE HEATER

ÜRÜN KODU	VOLT	WATT	BORU ÇAP (Ø)	(AISI)	ÖLÇÜ / MM
ED0016	230-380V	5500 W	8,5	304	A:400 B:100



DÖNER REZİSTANSLARI

ROTARY HEATERS

ÜRÜN KODU	VOLT	WATT	BORU ÇAP (Ø)	(AISI)	ÖLÇÜ / MM
ED0017	230V	1500 W	8,1	304	A:321 B:95,5
ED0018	230V	1500 W	8,1	304	A:321 B:95,5



KARE FLANSLI ENDÜSTRİYEL DALDIRMA TİPİ REZİSTANS

SQUARE FLANGED INDUSTRIAL IMMERSION TYPE HEATER

ÜRÜN KODU	VOLT	WATT	BORU ÇAP (Ø)	(AISI)	ÖLÇÜ / MM
ED0019	230V	3X3000 W	8,5	304	A:385 B:105

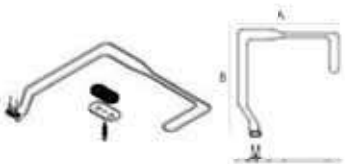

ÇAMAŞIR MAKİNESİ REZİSTANSI

WASHING MACHINE RESISTANCE

ÜRÜN KODU	VOLT	WATT	BORU ÇAP (Ø)	(AISI)	ÖLÇÜ / MM
ED0020	230V	2000 W	8,1	304	A:430 B:470



ÇAMAŞIR MAKİNESİ REZİSTANSI

WASHING MACHINE RESISTANCE

ÜRÜN KODU	VOLT	WATT	BORU ÇAP (Ø)	(AISI)	ÖLÇÜ / MM
ED0021	230V	2000 W	8,1	304	A:361 B:500



FRİTÖZ REZİSTANSI

FRYER HEATER

ÜRÜN KODU	VOLT	WATT	BORU ÇAP (Ø)	(AISI)	ÖLÇÜ / MM
ED0022	230V	2700 W	8,5	304	A:100 B:235 C:180



FRİTÖZ REZİSTANSI

FRYER HEATER

ÜRÜN KODU	VOLT	WATT	BORU ÇAP (Ø)	(AISI)	ÖLÇÜ / MM
ED0023	230V	2500 W	8,5	304	A:125 B:287 C:175



FRİTÖZ REZİSTANSLARI

FRYER HEATERS

ÜRÜN KODU	VOLT	WATT	BORU ÇAP (Ø)	(AISI)	ÖLÇÜ / MM
ED0024	230V	3000 W	8,5	304	A:158 B:282 C:175
ED0025	230V	3000 W	8,5	304	A:198,5 B:282 C:230

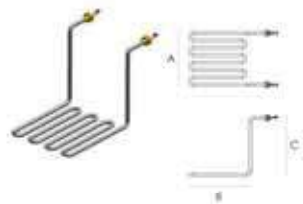

FRİTÖZ REZİSTANSI

FRYER HEATER

ÜRÜN KODU	VOLT	WATT	BORU ÇAP (Ø)	(AISI)	ÖLÇÜ / MM
ED0026	230V	4000 W	8,5	304	A:173 B:2266 C:190

ENDÜSTRİYEL GRUP REZİSTANSLARI

INDUSTRIAL GROUP HEATERS



FRİTÖZ REZİSTANSI

FRYER HEATER

ÜRÜN KODU	VOLT	WATT	BORU ÇAPI (Ø)	(AISI)	ÖLÇÜ / MM
ED0027	380V	3500 W	8,3	304	A:45 B:370 C:185



FRİTÖZ REZİSTANSLARI

FRYER HEATERS

ÜRÜN KODU	VOLT	WATT	BORU ÇAPI (Ø)	(AISI)	ÖLÇÜ / MM
ED0028	230V	3500 W	8,5	304	A:60 B:273 C:170
ED0029	230V	2500 W	8,5	304	A:60 B:273 C:230

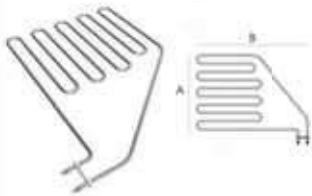

SAUNA TİPİ REZİSTANSI

SAUNA TYPE HEATER

ÜRÜN KODU	VOLT	WATT	BORU ÇAPI (Ø)	(AISI)	ÖLÇÜ / MM
ED0030	220V	2650 W	8,5	304	A:339 B:512

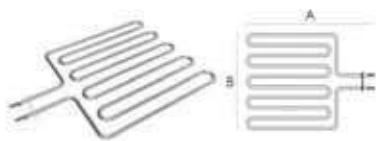

SAUNA REZİSTANSI

SAUNA HEATER

ÜRÜN KODU	VOLT	WATT	BORU ÇAPI (Ø)	(AISI)	ÖLÇÜ / MM
ED0031	230V	2670 W	8,5	304	A:382 B:298



SAUNA REZİSTANSLARI

SAUNA HEATERS

ÜRÜN KODU	VOLT	WATT	BORU ÇAPI (Ø)	(AISI)	ÖLÇÜ / MM
ED0032	230 V	2000 W	8,5	304	A:350 B:88
ED0033	230 V	2000 W	8,5	304	A:515 B:88
ED0034	230 V	3000 W	8,5	304	A:515 B:88



SAUNA TİPİ REZİSTANS

SAUNA TYPE HEATER

ÜRÜN KODU	VOLT	WATT	BORU ÇAPI (Ø)	(AISI)	ÖLÇÜ / MM
ED0035	230 V	1500 W	8,5	304	A:365 B:298

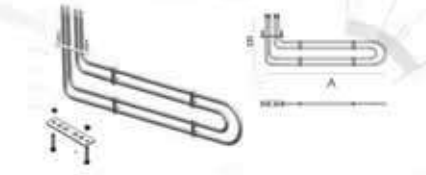

ÇİFTLİ FIRIN REZİSTANSI

DOUBLE OVEN HEATER

ÜRÜN KODU	VOLT	WATT	BORU ÇAPI (Ø)	(AISI)	ÖLÇÜ / MM
ED0036	230 V	1000-2000 W	8,5	304	A:536 B:205

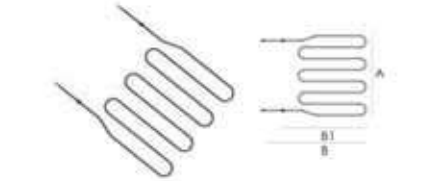

PIZZA FIRIN REZİSTANSI

PIZZA OVEN HEATER

ÜRÜN KODU	VOLT	WATT	BORU ÇAPI (Ø)	(AISI)	ÖLÇÜ / MM
ED0037	230 V	2000 W	8,5	304	A:515 B1:480 C:600

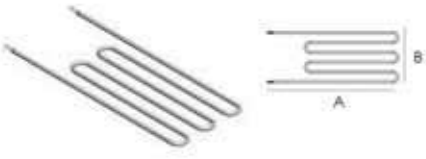

PIZZA FIRIN REZİSTANSI

PIZZA OVEN HEATER

ÜRÜN KODU	VOLT	WATT	BORU ÇAPI (Ø)	(AISI)	ÖLÇÜ / MM
ED0038	230 V	1800 W	8,5	304	A:473 B:195

PİRİNÇ KAFALI REZİSTANSLAR

BRASS HEAD HEATERS

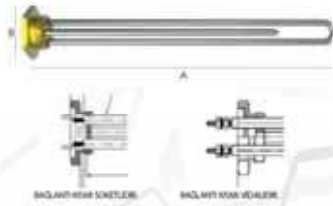

1 1/4" DÜZ KROM TERMOVAT REZİSTANSLAR 1 1/4" FLAT CHROME THERMOVATE HEATERS

ÜRÜN KODU	VOLT	WATT	BORU ÇAP (Ø)	(AISI)	ÖLÇÜ / MM
114DK0002	230V	1000 W	8,5	304	A:300 B:54,5
114DK0003	230V	1500 W	8,5	304	A:300 B:54,5
114DK0004	230V	2000 W	8,5	304	A:300 B:54,5
114DK0001	230V	2000 W	8,5	304	A:200 B:54,5
114DK0005	230V	3000 W	8,5	304	A:400 B:135
114DK0006	230V	3000 W	8,5	304	A:600 B:54,5
114DK0007	230V	3000 W	8,5	304	A:900 B:54,5

1 1/4" DÜZ BAKIR REZİSTANSLAR 1 1/4" FLAT COPPER HEATERS

ÜRÜN KODU	VOLT	WATT	BORU ÇAP (Ø)	(AISI)	ÖLÇÜ / MM
114DB0001	230V	2000 W	8,3	BAKIR	A:280 B:54,5
114DB0002	230V	2000 W	8,3	BAKIR	A:350 B:54,5
114DB0004	230V	3000 W	8,3	BAKIR	A:400 B:54,5
114DB0005	230V	3000 W	8,3	BAKIR	A:600 B:54,5
114DB0006	230V	3000 W	8,3	BAKIR	A:900 B:54,5

1 1/4" BÜKÜMLÜ KROM TERMOVAT REZİSTANSLAR 1 1/4" TWISTED CHROME THERMOVATE HEATERS

ÜRÜN KODU	VOLT	WATT	BORU ÇAP (Ø)	(AISI)	ÖLÇÜ / MM
114KX0001	230V	2000 W	8,5	304	A:300 B:54,5
114KX0002	230V	2500 W	8,5	304	A:300 B:54,5
114KX0003	230V	1800 W	8,5	304	A:300 B:54,5

1 1/4" BÜKÜMLÜ BAKIR REZİSTANSLAR 1 1/4" TWISTED COPPER HEATERS

ÜRÜN KODU	VOLT	WATT	BORU ÇAP (Ø)	(AISI)	ÖLÇÜ / MM
114KB0001	230V	2000 W	8,3	BAKIR	A:300 B:54,5
114KB0002	230V	3000 W	8,3	BAKIR	A:300 B:54,5

PİRİNÇ KAFALI REZİSTANSLAR

BRASS HEAD HEATERS

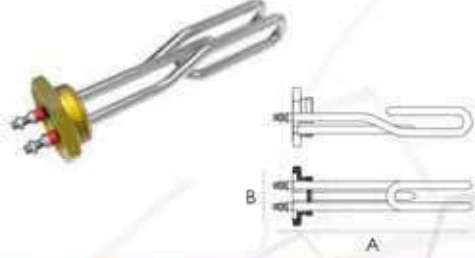

1 1/4" BÜKÜMLÜ KROM TERMOVAT REZİSTANS 1 1/4" TWISTED CHROME THERMOVATE HEATERS

ÜRÜN KODU	VOLT	WATT	BORU ÇAPI (Ø)	(AISI)	ÖLÇÜ / MM
114KX0004	230V	1750 W	8,5	304	A:190,5 B:55



1 1/4" BÜKÜMLÜ KROM TERMOVAT REZİSTANS 1 1/4" TWISTED CHROME THERMOVATE HEATERS

ÜRÜN KODU	VOLT	WATT	BORU ÇAPI (Ø)	(AISI)	ÖLÇÜ / MM
114KX0005	230V	1500 + 1500 W	8,1	304	A:200,5 B:49,5



1 1/4" KROM İKİ ELEMANLI REZİSTANS 1 1/4" CHROME TWO ELEMENT HEATERS

ÜRÜN KODU	VOLT	WATT	BORU ÇAPI (Ø)	(AISI)	ÖLÇÜ / MM
114KX0006	230V	1000 + 1000 W	8,5	INCOLOY	A:300,5 B:54,5



1 1/4" TRİFAZE KROM REZİSTANSLAR 1 1/4" THREE-PHASE CHROME HEATERS

ÜRÜN KODU	VOLT	WATT	BORU ÇAPI (Ø)	(AISI)	ÖLÇÜ / MM
114KTRF0001	230-380V	3000 W	8,5	304	A:300 B:55
114KTRF0002	230-380V	4500 W	8,5	304	A:300 B:55
114KTRF0003	230-380V	6000 W	8,5	304	A:300 B:55
114KTRF0004	230-380V	7500 W	8,5	304	A:300 B:55
114KTRF0005	230-380V	9000 W	8,5	304	A:300 B:55

PİRİNÇ KAFALI REZİSTANSLAR

BRASS HEAD HEATERS



1 1/4" BÜKÜMLÜ KROM REZİSTANSLAR

1 1/4" TWISTED CHROME HEATERS

ÜRÜN KODU	VOLT	WATT	BORU ÇAPI (Ø)	(AISI)	ÖLÇÜ / MM
114B0001	230V	800 W	8,1	304	A:300 B:54,5
114B0002	230V	1000 W	8,1	304	A:330 B:54,5
114B0003	230V	1200 W	8,1	304	A:360 B:54,5
114B0004	230V	1500 W	8,1	304	A:380 B:54,5
114B0005	230V	2000 W	8,1	304	A:400 B:54,5
114B0006	230V	2500 W	8,1	304	A:420 B:54,5
114B0007	230V	3000 W	8,1	304	A:440 B:54,5
114B0008	230V	500 W	8,1	304	A:300 B:54,5



1" KROM TERMOVAT REZİSTANSLAR

1" CHROME THERMOWATT HEATERS

ÜRÜN KODU	VOLT	WATT	BORU ÇAPI (Ø)	(AISI)	ÖLÇÜ / MM
B10003	230V	700 W	6,5	304	A:350 B:43
B10004	230V	1000 W	6,5	304	A:390 B:43
B10005	230V	1200 W	6,5	304	A:420 B:43
B10006	230V	1500 W	6,5	304	A:450 B:43
B10007	230V	2000 W	6,5	304	A:500 B:43
B10002	230V	500 W	6,5	304	A:300 B:43
B10001	230V	270 W	6,5	304	A:270 B:43



1" KROM TERMOVAT REZİSTANS

1" CHROME THERMOVATE HEATERS

ÜRÜN KODU	VOLT	WATT	BORU ÇAPI (Ø)	(AISI)	ÖLÇÜ / MM
B10008	230-330V	800 W	8,1	304	A:370 B:12
B10009	230-330V	900 W	8,1	304	A:430 B:12
B10010	230-330V	1000 W	8,1	304	A:430 B:12
B10011	230-330V	1200 W	8,1	304	A:430 B:12



REZİSTANS KILIFLI

HEATER SHEATHED

ÜRÜN KODU	VOLT	WATT	BORU ÇAPI (Ø)	(AISI)	ÖLÇÜ / MM
B10012	230V	2000 W	8,5	304	A:425 B:62,5

PİRİNÇ KAFALI REZİSTANSLAR

BRASS HEAD HEATERS



1 1/2" BÜKÜMLÜ KROM POT REZİSTANSLAR 1 1/2" TWISTED CHROME POT HEATERS

ÜRÜN KODU	VOLT	WATT	BORU ÇAP (Ø)	(AISI)	ÖLÇÜ / MM
112P0001	230 V	2000 W	8,5	304	A:260 B:61
112P0002	230 V	2500 W	8,5	304	A:260 B:61
112P0003	230 V	3000 W	8,5	304	A:333 B:61



1 1/2" ELEMANLI MALKAN KROM VE BAKIR REZİSTANSLAR 1 1/2" ELEMENT MALKAN CHROME AND COPPER HEATERS

ÜRÜN KODU	VOLT	WATT	BORU ÇAP (Ø)	(AISI)	ÖLÇÜ / MM
112M0001	230 V	2X2000 W	8,5	304	A:203 B:61
112M0002	230 V	2X2500 W	8,5	304	A:203 B:61
112M0003	230 V	2X2500 W	8,5	BAKIR	A:203 B:61



1 1/2" BAKIR TRİFAZE REZİSTANSLAR 1 1/2" COPPER THREE-PHASE HEATERS

ÜRÜN KODU	VOLT	WATT	BORU ÇAP (Ø)	(AISI)	ÖLÇÜ / MM
112TRF0002B	230-380 V	3X1500 W	8,3	BAKIR	A:290 B:61
112TRF0003B	230-380 V	3X2000 W	8,3	BAKIR	A:290 B:61
112TRF0004B	230-380 V	3X2500 W	8,3	BAKIR	A:290 B:61
112TRF0006B	230-380 V	3X3333 W	8,3	BAKIR	A:400 B:61
112TRF0007B	230-380 V	3X4000 W	8,3	BAKIR	A:450 B:61
112TRF0008B	230-380 V	3X5000 W	8,3	BAKIR	A:500 B:61



1 1/2" KROM TRİFAZE REZİSTANSLAR 1 1/2" CHROME THREE-PHASE HEATERS

ÜRÜN KODU	VOLT	WATT	BORU ÇAP (Ø)	(AISI)	ÖLÇÜ / MM
112TRF0001	230-380 V	3X1000 W	8,5	304	A:290 B:61
112TRF0002	230-380 V	3X1500 W	8,5	304	A:290 B:61
112TRF0003	230-380 V	3X2000 W	8,5	304	A:290 B:61
112TRF0004	230-380 V	3X2500 W	8,5	304	A:290 B:61
112TRF0005	230-380 V	3X3000 W	8,5	304	A:350 B:61
112TRF0006	230-380 V	3X3333 W	8,5	304	A:400 B:61
112TRF0007	230-380 V	3X4000 W	8,5	304	A:450 B:61
112TRF0008	230-380 V	3X5000 W	8,5	304	A:500 B:61

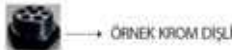

PİRİNÇ KAFALI REZİSTANSLAR

BRASS HEAD HEATERS



2" SOMUNLU İLAÇ DOLGULU KAZAN REZİSTANSLARI 2" NUTTED MEDICINE FILLED BOILER HEATERS

ÜRÜN KODU	VOLT	WATT	BORU ÇAP (Ø)	(AISI)	ÖLÇÜ / MM
200FLK0010	230-380 V	3X2500 W	8,5	304	A:350 B:30
200FLK0011	230-380 V	3X3333 W	8,5	304	A:400 B:30



2" BAKIR TRİFAZE REZİSTANSLAR 2" COPPER THREE-PHASE HEATERS

ÜRÜN KODU	VOLT	WATT	BORU ÇAP (Ø)	(AISI)	ÖLÇÜ / MM
200TRF0001H	230-380 V	3X1000 W	8,3	BAKIR	A:280 B:73,5
200TRF0002B	230-380 V	3X1500 W	8,3	BAKIR	A:295 B:73,5
200TRF0003B	230-380 V	3X2000 W	8,3	BAKIR	A:350 B:73,5
200TRF0004B	230-380 V	3X2500 W	8,3	BAKIR	A:350 B:73,5
200TRF0005B	230-380 V	3X3000 W	8,3	BAKIR	A:400 B:73,5
200TRF0007B	230-380 V	3X3333 W	8,3	BAKIR	A:450 B:73,5
200TRF0006B	230-380 V	3X3000W	8,3	BAKIR	A:350 B:73,5
200TRF0008B	230-380 V	3X5000 W	8,3	BAKIR	A:500 B:73,5



2" KROM TRİFAZE REZİSTANSLAR 2" CHROME THREE-PHASE HEATERS

ÜRÜN KODU	VOLT	WATT	BORU ÇAP (Ø)	(AISI)	ÖLÇÜ / MM
200TRF0001	230-380 V	3X1000 W	8,5	304	A:280 B:73,5
200TRF0002	230-380 V	3X1500 W	8,5	304	A:295 B:73,5
200TRF0003	230-380 V	3X2000 W	8,5	304	A:350 B:73,5
200TRF0004	230-380 V	3X2500 W	8,5	304	A:350 B:73,5
200TRF0006	230-380 V	3X3000 W	8,5	304	A:400 B:73,5
200TRF0005	230-380 V	3X3333 W	8,5	304	A:450 B:73,5
200TRF0007	230-380 V	3X3000W	8,5	304	A:350 B:73,5
200TRF0008	230-380 V	3X5000 W	8,5	304	A:500 B:73,5
200TRF0010	230-380 V	3X3333 W	8,5	304	A:700 B:73,5
200TRF0011	230-380 V	3X5000 W	8,5	304	A:800 B:73,5
200TRF0012	230-380 V	3X5000 W	8,5	304	A:900 B:73,5
200TRF0013	230-380 V	3X5000 W	8,5	304	A:1000 B:73,5



2" MALKAN REZİSTANSLAR

2" MALKAN HEATERS

ÜRÜN KODU	VOLT	WATT	BORU ÇAP (Ø)	(AISI)	ÖLÇÜ / MM
200FLK0003	230-380 V	3X3333 W	8,5	304	A:220 B:73,5
200FLK0003B	230-380 V	3X3333 W	8,5	BAKIR	A:220 B:73,5
200FLK0002	230-380 V	3X2500 W	8,5	304	A:220 B:73,5
200FLK0002B	230-380 V	3X2500 W	8,5	BAKIR	A:220 B:73,5
200FLK0001	230-380 V	3X2000 W	8,5	304	A:220 B:73,5
200FLK0001B	230-380 V	3X2000 W	8,5	BAKIR	A:220 B:73,5
200FLK0006	230-380 V	3X3333 W	8,5	304	A:270 B:73,5
200FLK0005	230-380 V	3X2500 W	8,5	304	A:270 B:73,5
200FLK0004	230-380 V	3X2000 W	8,5	304	A:270 B:73,5
200FLK0009	230-380 V	3X3333 W	8,5	304	A:330 B:73,5
200FLK0008	230-380 V	3X2500 W	8,5	304	A:330 B:73,5



ÇAMAŞIR MAKİNESİ REZİSTANSLARI

WASHING MACHINE HEATERS



SENSÖR DELİKLİ REZİSTANSLAR

HEATERS WITH SENSOR HOLE

ÜRÜN KODU	VOLT	WATT	BORU ÇAP (Ø)	(AISI)	ÖLÇÜ / MM
ÇMS00001	230V	1700 W	8,5	304	A:165 B:135
ÇMS00002	230V	1800 W	8,5	304	A:170 B:110
ÇMS00003	230V	1900 W	8,5	304	A:185 B:125
ÇMS00004	230V	1950 W	8,5	304	A:190 B:195
ÇMS00005	230V	2000 W	8,5	304	A:195 B:140
ÇMS00006	230V	2000 W	8,5	304	A:220 B:140
ÇMS00007	230V	2000 W	8,5	304	A:240 B:140



SENSÖR DELİKLİ REZİSTANSLAR

HEATERS WITH SENSOR HOLE

ÜRÜN KODU	VOLT	WATT	BORU ÇAP (Ø)	(AISI)	ÖLÇÜ / MM
ÇM0001	230V	1700 W	8,5	304	A:165 B:135
ÇM0002	230V	1800 W	8,5	304	A:170 B:110
ÇM0003	230V	1900 W	8,5	304	A:185 B:125
ÇM0004	230V	1950 W	8,5	304	A:190 B:195
ÇM0005	230V	2000 W	8,5	304	A:195 B:140
ÇM0006	230V	2000 W	8,5	304	A:220 B:140
ÇM0007	230V	2000 W	8,5	304	A:240 B:140

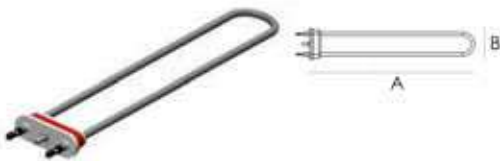

TANK REZİSTANSI

TANK HEATER

ÜRÜN KODU	VOLT	WATT	BORU ÇAP (Ø)	(AISI)	ÖLÇÜ / MM
ÇM0008	230V	3250 W	8,5	INCOLOY	A:420,5 B:95



ÇAMAŞIR MAKİNESİ REZİSTANSLARI

WASHING MACHINE HEATERS

ÜRÜN KODU	VOLT	WATT	BORU ÇAP (Ø)	(AISI)	ÖLÇÜ / MM
ÇM0009	230V	1950 W	8,5	304	A:80,5 B:300 B1:243
ÇM0010	230V	2850 W	8,5	304	A:80,5 B:320 B1:255

ÇAMAŞIR MAKİNESİ REZİSTANSLARI

WASHING MACHINE HEATERS

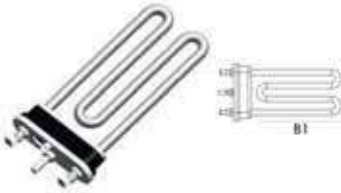

ÇAMAŞIR MAKİNESİ REZİSTANSLARI

WASHING MACHINE HEATERS

ÜRÜN KODU	VOLT	WATT	BORU ÇAP (Ø)	(AISI)	ÖLÇÜ / MM
ÇM0011	230V	4000 W	8,5	304	A:350 B:250
ÇM0012	230V	4000 W	8,5	304	A:400 B:300
ÇM0013	230V	5000 W	8,5	304	A:500 B:400

KAZAN REZİSTANSI (EĞRİ)

BOILER HEATER (CURVE)

ÜRÜN KODU	VOLT	WATT	BORU ÇAP (Ø)	(AISI)	ÖLÇÜ / MM
ÇM0014	230V	3000 W	8,3	304	A:360 B:60
ÇM0015	230V	4000 W	8,3	304	A:440 B:70
ÇM0016	230V	5000 W	8,3	304	A:485 B:70

TANK REZİSTANSI

TANK HEATER

ÜRÜN KODU	VOLT	WATT	BORU ÇAP (Ø)	(AISI)	ÖLÇÜ / MM
ÇM0017	230V	3000 W	8,3	304	A:470 B:65 B:50

ÇAMAŞIR MAKİNESİ REZİSTANSLARI

WASHING MACHINE HEATERS

ÜRÜN KODU	VOLT	WATT	BORU ÇAP (Ø)	(AISI)	ÖLÇÜ / MM
ÇM0018	230V	1700 W	8,5	304	A&Y:B:170 B1:150



TERMOSİFON - ŞOFBEN REZİSTANSLARI

THERMOSIFFON - GEYSER HEATERS



ŞOFBEN REZİSTANSLARI

GEYSER HEATERS

ÜRÜN KODU	VOLT	WATT	BORU ÇAP (Ø)	(AISI)	ÖLÇÜ / MM
TS0001	230V	4500+3000 W	6,5	304	A:140 B:84



ŞOFBEN REZİSTANSLARI

GEYSER HEATERS

ÜRÜN KODU	VOLT	WATT	BORU ÇAP (Ø)	(AISI)	ÖLÇÜ / MM
TS0002	230V	4250+3000 W	6,5	304	A:205 B:77
TS0003	230V	5000+4000 W	6,5	304	A:205 B:77



BÜKÜMLÜ KROM REZİSTANSLAR

TWISTED CHROME HEATERS

ÜRÜN KODU	VOLT	WATT	BORU ÇAP (Ø)	(AISI)	ÖLÇÜ / MM
TS0004	230V	1200 W	8,5	316	A:135 B:91
TS0005	230V	1500 W	8,5	316	A:135 B:91



TERMOSİFON REZİSTANSI

THERMOSYPHON HEATER

ÜRÜN KODU	VOLT	WATT	BORU ÇAP (Ø)	(AISI)	ÖLÇÜ / MM
TS0006	230V	1950 W	8,5	304	A:355 B:125



BAKIR TERMOSİFON REZİSTANS

COPPER THERMOSYPHON HEATER

ÜRÜN KODU	VOLT	WATT	BORU ÇAP (Ø)	(AISI)	ÖLÇÜ / MM
TS0007	230V	2000 W	8,3	BAKIR	A:270 B:106

TERMOSİFON - ŞOFBEN REZİSTANSLARI

THERMOSIFFON - GEYSER HEATERS



KROM TERMOSİFON REZİSTANS

CHROME THERMOSIPHONE HEATER

ÜRÜN KODU	VOLT	WATT	BORU ÇAPI (Ø)		ÖLÇÜ / MM
			(Ø)	(AISI)	
TS0008	230V	2000 W	8,5	304	A:270,5 B:106



TERMOSİFON REZİSTANSI

THERMOSIPHONE HEATER

ÜRÜN KODU	VOLT	WATT	BORU ÇAPI (Ø)		ÖLÇÜ / MM
			(Ø)	(AISI)	
TS0009	230V	2000 W	8,1	304	A:379 B:128



MONOFAZE REZİSTANSI

SINGLEPHASE HEATER

ÜRÜN KODU	VOLT	WATT	BORU ÇAPI (Ø)		ÖLÇÜ / MM
			(Ø)	(AISI)	
TS0010	230V	1950 W	8,5	304	A:4258:63,5



TERMOSİFON REZİSTANSI

THERMOSIPHONE HEATER

ÜRÜN KODU	VOLT	WATT	BORU ÇAPI (Ø)		ÖLÇÜ / MM
			(Ø)	(AISI)	
TS0011	230V	2000 W	8,5	304	A:265 B:90



BÜKÜMLÜ KROM REZİSTANS

TWISTED CHROME HEATER

ÜRÜN KODU	VOLT	WATT	BORU ÇAPI (Ø)		ÖLÇÜ / MM
			(Ø)	(AISI)	
TS0012	230V	2000 W	8,5	304	A:370 B:90

TERMOSİFON - ŞOFBEN REZİSTANSLARI

THERMOSIFFON - GEYSER HEATERS



TERMOVAT REZİSTANSI

TERMOVAT HEATER

ÜRÜN KODU	VOLT	WATT	BORU		ÖLÇÜ / MM
			ÇAPI (Ø)	(AISI)	
TS0013	230V	1800 W	8,5	304	A:168,5, B:124



TERMOSİFON KROM VE BAKIR REZİSTANSLAR

THERMOSYPHON CHROME AND COPPER HEATERS

ÜRÜN KODU	VOLT	WATT	BORU		ÖLÇÜ / MM
			ÇAPI (Ø)	(AISI)	
TS0014	230V	2000 W	8,5	304	A:379 B:64
TS0015	230V	2000 W	8,3	BAKIR	A:379 B:64
TS0016	230V	2000 W	8,5	304	A:365 B:64



DÜZ BAKIR REZİSTANSLAR (RFD SERİSİ)

FLAT COPPER HEATERS (RFD SERIES)

ÜRÜN KODU	VOLT	WATT	BORU		ÖLÇÜ / MM
			ÇAPI (Ø)	(AISI)	
TS0017	230V	1000 W	8,3	BAKIR	A:275 B:48
TS0018	230V	1200 W	8,3	BAKIR	A:275 B:48
TS0019	230V	1500 W	8,3	BAKIR	A:275 B:48
TS0020	230V	2000 W	8,3	BAKIR	A:275 B:48
TS0021	230V	1200 W	8,3	BAKIR	A:275 B:48
TS0022	230V	1500 W	8,3	BAKIR	A:275 B:48
TS0023	230V	1200 W	8,3	BAKIR	A:260 B:48
TS0024	230V	1500 W	8,3	BAKIR	A:260 B:48



YUVARLAK BAŞLI BİRİNCİLİ BAKIR REZİSTANSLAR (HFC SERİSİ)

HORIZONTAL HEAD CURVED COPPER HEATER (HFC SERIES)

ÜRÜN KODU	VOLT	WATT	BORU		ÖLÇÜ / MM
			ÇAPI (Ø)	(AISI)	
TS0025	230V	2000 W	8,3	BAKIR	A:180 B:160
TS0026	230V	2000 W	8,3	BAKIR	A:180 B:160



KROM/BAKIR TERMOSİFON REZİSTANSLAR

CHROME/COPPER THERMOSYPHON HEATERS

ÜRÜN KODU	VOLT	WATT	BORU		ÖLÇÜ / MM
			ÇAPI (Ø)	(AISI)	
TS0027	230V	1300 W	8,1	304	A:310 B:64,5
TS0028	230V	1300 W	8,3	BAKIR	A:316 B:64,5

TOST REZİSTANSLARI

TOAST HEATERS



TOST REZİSTANSI

TOAST HEATER

ÜRÜN KODU	VOLT	WATT	BORU		ÖLÇÜ / MM
			ÇAPI (Ø)	(AISI)	
TST0001	110V	750 W	6,5	304	A:237 B:135

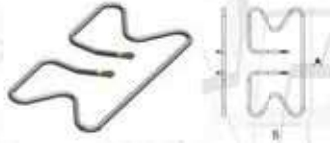

TOST REZİSTANSI

TOAST HEATER

ÜRÜN KODU	VOLT	WATT	BORU		ÖLÇÜ / MM
			ÇAPI (Ø)	(AISI)	
TST0002	110V	1000 W	6,5	304	A:260 B:140



TOST REZİSTANSLARI

TOAST HEATERS

ÜRÜN KODU	VOLT	WATT	BORU		ÖLÇÜ / MM
			ÇAPI (Ø)	(AISI)	
TST0003	110V	400 W	6,5	304	A:145 B:60
TST0004	110V	350 W	6,5	304	A:183 B:65



TOST REZİSTANSI

TOAST HEATER

ÜRÜN KODU	VOLT	WATT	BORU		ÖLÇÜ / MM
			ÇAPI (Ø)	(AISI)	
TST0005	230V	650 W	8,5	304	A:177,7 B:150



TOST REZİSTANSLARI

TOAST HEATERS

ÜRÜN KODU	VOLT	WATT	BORU		ÖLÇÜ / MM
			ÇAPI (Ø)	(AISI)	
TST0006	220V	1000 W	6,5	304	A:290 B:210

TOST REZİSTANSLARI

TOAST HEATERS

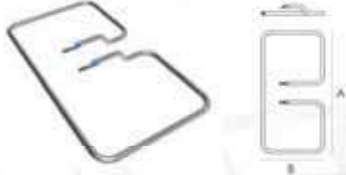

TOST REZİSTANSI			TOAST HEATER		
ÜRÜN KODU	VOLT	WATT	BORU ÇAP (Ø)	(AISI)	ÖLÇÜ / MM
TST0007	230V	850 W	6,5	304	A:240 B:127

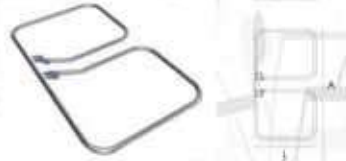

TOST REZİSTANSLARI			TOAST HEATERS		
ÜRÜN KODU	VOLT	WATT	BORU ÇAP (Ø)	(AISI)	ÖLÇÜ / MM
TST0008	115V	900 W	6,5	304	A:262 B:152,5
TST0009	115V	900 W	6,5	304	A:241 B:104,5



TOST REZİSTANSI			TOAST HEATER		
ÜRÜN KODU	VOLT	WATT	BORU ÇAP (Ø)	(AISI)	ÖLÇÜ / MM
TST0010	115V	900 W	6,5	304	A:233 B:156,5 C:116,5



TOST REZİSTANSI			TOAST HEATER		
ÜRÜN KODU	VOLT	WATT	BORU ÇAP (Ø)	(AISI)	ÖLÇÜ / MM
TST0011	110V	1000 W	6,5	304	A:230 B:150



TOST REZİSTANSLARI			TOAST HEATERS		
ÜRÜN KODU	VOLT	WATT	BORU ÇAP (Ø)	(AISI)	ÖLÇÜ / MM
TST0012	220V	750 W	6,5	304	A:230 B:150
TST0013	110V	750 W	6,5	304	A:230 B:150

TOST REZİSTANSLARI

TOAST HEATERS

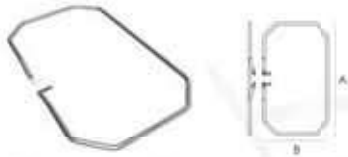

TOST REZİSTANSI			TOAST HEATER		
ÜRÜN KODU	VOLT	WATT	BORU ÇAPI (Ø)	(AISI)	ÖLÇÜ / MM
TST0014	115V	1000 W	6,5	304	A:260 B:157,5



TOST REZİSTANSI			TOAST HEATER		
ÜRÜN KODU	VOLT	WATT	BORU ÇAPI (Ø)	(AISI)	ÖLÇÜ / MM
TST0015	115V	800 W	6,5	304	A:215 B:150 C:160

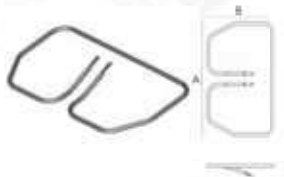

TOST REZİSTANSI			TOAST HEATER		
ÜRÜN KODU	VOLT	WATT	BORU ÇAPI (Ø)	(AISI)	ÖLÇÜ / MM
TST0016	115V	900 W	6,5	304	A:260 B:158



TOST REZİSTANSI			TOAST HEATER		
ÜRÜN KODU	VOLT	WATT	BORU ÇAPI (Ø)	(AISI)	ÖLÇÜ / MM
TST0017	115V	1000 W	6,5	304	A:260 B:158



TOST REZİSTANSLARI			TOAST HEATERS		
ÜRÜN KODU	VOLT	WATT	BORU ÇAPI (Ø)	(AISI)	ÖLÇÜ / MM
TST0018	126,5V	1100 W	6,5	304	A:263 B:145
TST0019	103,5V	1000 W	8,5	304	A:263 B:145



TURBO REZİSTANSI

TURBO HEATER

ÜRÜN KODU	VOLT	WATT	BORU ÇAP (Ø)	(AISI)	ÖLÇÜ / MM
FR0001	230V	2400 W	6,5	304	A:213 B:221



TURBO REZİSTANSLARI

TURBO HEATERS

ÜRÜN KODU	VOLT	WATT	BORU ÇAP (Ø)	(AISI)	ÖLÇÜ / MM
FR0002	230 V	2600 W	6,5	304	A:192,5 B:238,25
FR0003	230 V	2600 W	6,5	304	A:192,5 B:238,25



TURBO REZİSTANSI

TURBO HEATER

ÜRÜN KODU	VOLT	WATT	BORU ÇAP (Ø)	(AISI)	ÖLÇÜ / MM
FR0004	230V	2500 W	6,5	304	A:209 B:192,5



TURBO REZİSTANSI

TURBO HEATER

ÜRÜN KODU	VOLT	WATT	BORU ÇAP (Ø)	(AISI)	ÖLÇÜ / MM
FR0005	230V	2300 W	6,5	304	A:194,5 B:245



FIRIN REZİSTANSLARI

OVEN HEATERS

ÜRÜN KODU	VOLT	WATT	BORU ÇAP (Ø)	(AISI)	ÖLÇÜ / MM
FR0006	230V	550 W	6,5	304	A:277 B:322
FR0007	230V	650 W	6,5	304	A:305 B:378

FIRIN REZİSTANSLARI

OVEN HEATERS



FIRIN REZİSTANSI			OVEN HEATER		
ÜRÜN KODU	VOLT	WATT	BORU ÇAP (Ø)	(AISI)	ÖLÇÜ / MM
FR0008	230V	650 W	6,5	304	A:246 B:305



FLANŞLI FIRIN REZİSTANSI			FLANGED OVEN HEATER		
ÜRÜN KODU	VOLT	WATT	BORU ÇAP (Ø)	(AISI)	ÖLÇÜ / MM
FR0009	230V	650 W	6,5	304	A:246 B:305



FIRIN REZİSTANSI			OVEN HEATER		
ÜRÜN KODU	VOLT	WATT	BORU ÇAP (Ø)	(AISI)	ÖLÇÜ / MM
FR0010	230V	1100 W	6,5	304	A:240 B:240



M TİPİ FIRIN REZİSTANS			M TYPE OVEN HEATER		
ÜRÜN KODU	VOLT	WATT	BORU ÇAP (Ø)	(AISI)	ÖLÇÜ / MM
FR0011	230V	700 W	6,5	304	A:363 B:240

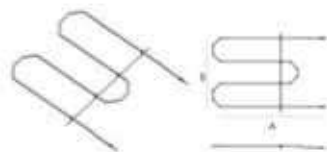

M TİPİ FIRIN REZİSTANS (GERGİ TELLİ)			M TYPE OVEN HEATER (WIRE TENSIONER)		
ÜRÜN KODU	VOLT	WATT	BORU ÇAP (Ø)	(AISI)	ÖLÇÜ / MM
FR0012	230V	700 W	6,5	304	A:363 B:240

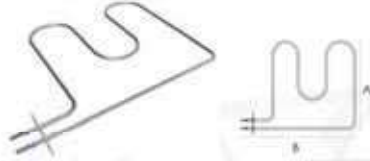

F TIPI REZİSTANSLAR (GERGİ TELLİ)

F TYPE RESISTANCES (TENSION WIRE)

ÜRÜN KODU	VOLT	WATT	BORU ÇAPI (Ø)		ÖLÇÜ / MM
			(AISI)		
FR0013	230 V	750 W	6,5	304	A:270 B:333
FR0014	230 V	800 W	6,5	304	A:380 B:253

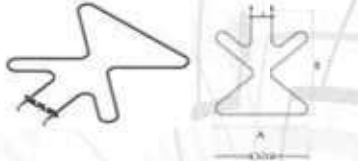

FIRIN REZİSTANSI

OVEN HEATER

ÜRÜN KODU	VOLT	WATT	BORU ÇAPI (Ø)		ÖLÇÜ / MM
			(AISI)		
FR0015	230 V	1100 W	6,5	304	A:348 B:385

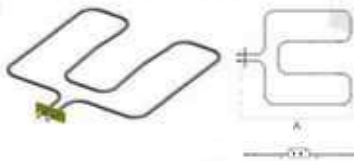

FIRIN REZİSTANSI

OVEN HEATER

ÜRÜN KODU	VOLT	WATT	BORU ÇAPI (Ø)		ÖLÇÜ / MM
			(AISI)		
FR0016	230 V	1200 W	6,4	304	A:428 B:361

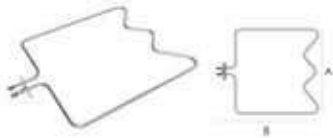

FIRIN REZİSTANSLARI

OVEN HEATERS

ÜRÜN KODU	VOLT	WATT	BORU ÇAPI (Ø)		ÖLÇÜ / MM
			(AISI)		
FR0017	230 V	1350 W	6,5	304	A:335 B:390
FR0018	230 V	1200 W	6,5	304	A:279 B:341



FIRIN REZİSTANSI

OVEN HEATER

ÜRÜN KODU	VOLT	WATT	BORU ÇAPI (Ø)		ÖLÇÜ / MM
			(AISI)		
FR0019	230 V	1200 W	6,5	304	A:309,5 B:355

FIRIN REZİSTANSLARI

OVEN HEATERS

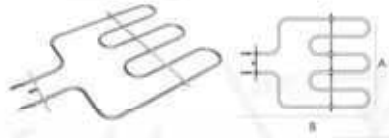

FIRIN REZİSTANSI			OVEN HEATER		
ÜRÜN KODU	VOLT	WATT	BORU ÇAPI (Ø)	(AISI)	ÖLÇÜ / MM
FRO020	230V	1300 W	6,5	304	A:256,5 B:345



FIRIN REZİSTANSI			OVEN HEATER		
ÜRÜN KODU	VOLT	WATT	BORU ÇAPI (Ø)	(AISI)	ÖLÇÜ / MM
FRO021	230V	2000 W	6,5	304	A:260 B:312

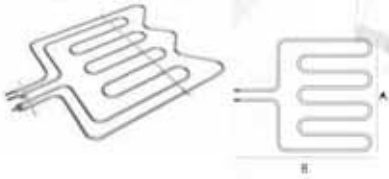

ÇİFT FIRIN REZİSTANSI			DOUBLE OVEN RESISTANCE		
ÜRÜN KODU	VOLT	WATT	BORU ÇAPI (Ø)	(AISI)	ÖLÇÜ / MM
FRO022	230V	1500+2000 W	6,5	304	A:335 B:408,5

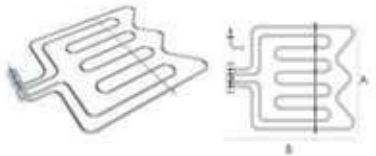

ÇİFT FIRIN REZİSTANSI			DOUBLE OVEN HEATER		
ÜRÜN KODU	VOLT	WATT	BORU ÇAPI (Ø)	(AISI)	ÖLÇÜ / MM
FRO023	230V	1500+2000 W	6,5	304	A:355 B:408,5



ÇİFT FIRIN REZİSTANSI			DOUBLE OVEN HEATER		
ÜRÜN KODU	VOLT	WATT	BORU ÇAPI (Ø)	(AISI)	ÖLÇÜ / MM
FRO024	230-240 V	1200+2000 W	6,5	304	A:381 B:365

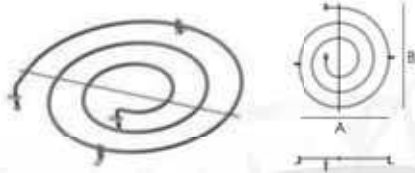

KATMER FIRIN REZİSTANSLARI

KATMER OVEN HEATERS

ÜRÜN KODU	VOLT	WATT	BORU ÇAP (Ø)	(AISI)	ÖLÇÜ / MM
FR0025	230V	2000 W	6,5	304	A:370 B:400
FR0026	230V	2200 W	6,5	304	A:370 B:400

BARBEKÜ REZİSTANSLARI

BARBECUE HEATER

ÜRÜN KODU	VOLT	WATT	BORU ÇAP (Ø)	(AISI)	ÖLÇÜ / MM
FR0027	230V	1500 W	6,5	304	A:325 B:410

BARBEKÜ REZİSTANSLARI

BARBECUE HEATERS

ÜRÜN KODU	VOLT	WATT	BORU ÇAP (Ø)	(AISI)	ÖLÇÜ / MM
FR0028	230V	2000 W	6,4	304	A:325 B:233,5

KATMER REZİSTANSI

KATMER HEATER

ÜRÜN KODU	VOLT	WATT	BORU ÇAP (Ø)	(AISI)	ÖLÇÜ / MM
FR0029	230V	650 W	6,5	304	A:330 B:408

BARBEKÜ REZİSTANSLARI

BARBECUE HEATERS

ÜRÜN KODU	VOLT	WATT	BORU ÇAP (Ø)	(AISI)	ÖLÇÜ / MM
FR0030	230V	2000 W	6,5	304	A:330 B:228,5

ÇUBUK REZİSTANSLAR

ROD HEATERS



ÇUBUK REZİSTANSLAR		ROD HEATERS			
ÜRÜN KODU	VOLT	WATT	BORU ÇAPI (Ø)	(AISI)	ÖLÇÜ / MM
65300300	110,115,127 V 220,230,240 V 380 V	300 W - 4500 W	6,5	304	300....3150
65300300	110,115,127 V 220,230,240 V 380 V	300 W - 4500 W	8,5	304	300....3150

ÜRÜN KODU	ÖLÇÜ cm	BORU ÇAPI(Ø)	
ÇBK06530	30 cm	Ø6,5	Tavlı Krom Çubuk Isıtıcı Soketli
ÇBK06540	40 cm	Ø6,5	Tavlı Krom Çubuk Isıtıcı Soketli
ÇBK06550	50 cm	Ø6,5	Tavlı Krom Çubuk Isıtıcı Soketli
ÇBK06560	60 cm	Ø6,5	Tavlı Krom Çubuk Isıtıcı Soketli
ÇBK06570	70 cm	Ø6,5	Tavlı Krom Çubuk Isıtıcı Soketli
ÇBK06580	80 cm	Ø6,5	Tavlı Krom Çubuk Isıtıcı Soketli
ÇBK06590	90 cm	Ø6,5	Tavlı Krom Çubuk Isıtıcı Soketli
ÇBK065100	100 cm	Ø6,5	Tavlı Krom Çubuk Isıtıcı Soketli
ÇBK065110	110 cm	Ø6,5	Tavlı Krom Çubuk Isıtıcı Soketli
ÇBK065120	120 cm	Ø6,5	Tavlı Krom Çubuk Isıtıcı Soketli
ÇBK065130	130 cm	Ø6,5	Tavlı Krom Çubuk Isıtıcı Soketli
ÇBK065140	140 cm	Ø6,5	Tavlı Krom Çubuk Isıtıcı Soketli
ÇBK065150	150 cm	Ø6,5	Tavlı Krom Çubuk Isıtıcı Soketli
ÇBK065160	160 cm	Ø6,5	Tavlı Krom Çubuk Isıtıcı Soketli
ÇBK065170	170 cm	Ø6,5	Tavlı Krom Çubuk Isıtıcı Soketli
ÇBK065180	180 cm	Ø6,5	Tavlı Krom Çubuk Isıtıcı Soketli
ÇBK065190	190 cm	Ø6,5	Tavlı Krom Çubuk Isıtıcı Soketli
ÇBK065200	200 cm	Ø6,5	Tavlı Krom Çubuk Isıtıcı Soketli
ÇBK065210	210 cm	Ø6,5	Tavlı Krom Çubuk Isıtıcı Soketli
ÇBK065220	220 cm	Ø6,5	Tavlı Krom Çubuk Isıtıcı Soketli
ÇBK065230	230 cm	Ø6,5	Tavlı Krom Çubuk Isıtıcı Soketli
ÇBK065240	240 cm	Ø6,5	Tavlı Krom Çubuk Isıtıcı Soketli
ÇBK065250	250 cm	Ø6,5	Tavlı Krom Çubuk Isıtıcı Soketli
ÇBK065260	260 cm	Ø6,5	Tavlı Krom Çubuk Isıtıcı Soketli
ÇBK065270	270 cm	Ø6,5	Tavlı Krom Çubuk Isıtıcı Soketli
ÇBK065280	280 cm	Ø6,5	Tavlı Krom Çubuk Isıtıcı Soketli
ÇBK065290	290 cm	Ø6,5	Tavlı Krom Çubuk Isıtıcı Soketli
ÇBK065300	300 cm	Ø6,5	Tavlı Krom Çubuk Isıtıcı Soketli

ÜRÜN KODU	ÖLÇÜ cm	BORU ÇAPI(Ø)	
ÇBK08530	30 cm	Ø 8,5	Tavlı Krom Çubuk Isıtıcı Soketli / Vidalı
ÇBK08540	40 cm	Ø 8,5	Tavlı Krom Çubuk Isıtıcı Soketli / Vidalı
ÇBK08550	50 cm	Ø 8,5	Tavlı Krom Çubuk Isıtıcı Soketli / Vidalı
ÇBK08560	60 cm	Ø 8,5	Tavlı Krom Çubuk Isıtıcı Soketli / Vidalı
ÇBK08570	70 cm	Ø 8,5	Tavlı Krom Çubuk Isıtıcı Soketli / Vidalı
ÇBK08580	80 cm	Ø 8,5	Tavlı Krom Çubuk Isıtıcı Soketli / Vidalı
ÇBK08590	90 cm	Ø 8,5	Tavlı Krom Çubuk Isıtıcı Soketli / Vidalı
ÇBK085100	100 cm	Ø 8,5	Tavlı Krom Çubuk Isıtıcı Soketli / Vidalı
ÇBK085110	110 cm	Ø 8,5	Tavlı Krom Çubuk Isıtıcı Soketli / Vidalı
ÇBK085120	120 cm	Ø 8,5	Tavlı Krom Çubuk Isıtıcı Soketli / Vidalı
ÇBK085130	130 cm	Ø 8,5	Tavlı Krom Çubuk Isıtıcı Soketli / Vidalı
ÇBK085140	140 cm	Ø 8,5	Tavlı Krom Çubuk Isıtıcı Soketli / Vidalı
ÇBK085150	150 cm	Ø 8,5	Tavlı Krom Çubuk Isıtıcı Soketli / Vidalı
ÇBK085160	160 cm	Ø 8,5	Tavlı Krom Çubuk Isıtıcı Soketli / Vidalı
ÇBK085170	170 cm	Ø 8,5	Tavlı Krom Çubuk Isıtıcı Soketli / Vidalı
ÇBK085180	180 cm	Ø 8,5	Tavlı Krom Çubuk Isıtıcı Soketli / Vidalı
ÇBK085190	190 cm	Ø 8,5	Tavlı Krom Çubuk Isıtıcı Soketli / Vidalı
ÇBK085200	200 cm	Ø 8,5	Tavlı Krom Çubuk Isıtıcı Soketli / Vidalı
ÇBK085210	210 cm	Ø 8,5	Tavlı Krom Çubuk Isıtıcı Soketli / Vidalı
ÇBK085220	220 cm	Ø 8,5	Tavlı Krom Çubuk Isıtıcı Soketli / Vidalı
ÇBK085230	230 cm	Ø 8,5	Tavlı Krom Çubuk Isıtıcı Soketli / Vidalı
ÇBK085240	240 cm	Ø 8,5	Tavlı Krom Çubuk Isıtıcı Soketli / Vidalı
ÇBK085250	250 cm	Ø 8,5	Tavlı Krom Çubuk Isıtıcı Soketli / Vidalı
ÇBK085260	260 cm	Ø 8,5	Tavlı Krom Çubuk Isıtıcı Soketli / Vidalı
ÇBK085270	270 cm	Ø 8,5	Tavlı Krom Çubuk Isıtıcı Soketli / Vidalı
ÇBK085280	280 cm	Ø 8,5	Tavlı Krom Çubuk Isıtıcı Soketli / Vidalı
ÇBK085290	290 cm	Ø 8,5	Tavlı Krom Çubuk Isıtıcı Soketli / Vidalı
ÇBK085300	300 cm	Ø 8,5	Tavlı Krom Çubuk Isıtıcı Soketli / Vidalı



HELEZON REZİSTANSI

HELIX HEATER

ÜRÜN KODU	VOLT	WATT	BORU ÇAP (Ø)	(AISI)	ÖLÇÜ / MM
ÖZLHV00001	230V	1000 W	8,5	304	A:130,5 B:89



HELEZON REZİSTANSI

HELIX HEATER

ÜRÜN KODU	VOLT	WATT	BORU ÇAP (Ø)	(AISI)	ÖLÇÜ / MM
ÖZLHV00002	230V	500 W	8,5	304	A:100 B:70



HELEZON REZİSTANSI

HELIX HEATER

ÜRÜN KODU	VOLT	WATT	BORU ÇAP (Ø)	(AISI)	ÖLÇÜ / MM
ÖZLHV00003	230V	1500 W	8,5	304	A:165B:117,5

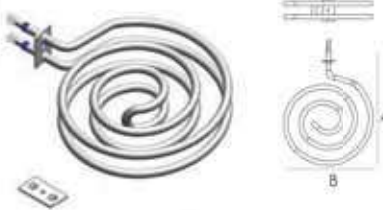

HELEZON REZİSTANSI

HELIX HEATER

ÜRÜN KODU	VOLT	WATT	BORU ÇAP (Ø)	(AISI)	ÖLÇÜ / MM
ÖZLHV00004	230V	2000 W	8,5	304	A:205 B:166



HELEZON REZİSTANSI

HELIX HEATER

ÜRÜN KODU	VOLT	WATT	BORU ÇAP (Ø)	(AISI)	ÖLÇÜ / MM
ÖZLHV00005	230V	3000 W	8,5	304	A:192 B:242

HAVALANDIRMA REZİSTANSLARI

VENTILATION HEATERS



HELEZON REZİSTANSI

HELIX HEATER

ÜRÜN KODU	VOLT	WATT	BORU		ÖLÇÜ / MM
			ÇAPI (Ø)	(AISI)	
ÖZLHV00006	230V	2000 W	8,5	304	A:245 B:179



HELEZON REZİSTANSI

HELIX HEATER

ÜRÜN KODU	VOLT	WATT	BORU		ÖLÇÜ / MM
			ÇAPI (Ø)	(AISI)	
ÖZLHV00007	230V	2500 W	8,5	304	A:245 B:179

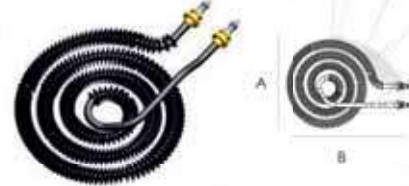

HELEZON REZİSTANSI

HELIX HEATER

ÜRÜN KODU	VOLT	WATT	BORU		ÖLÇÜ / MM
			ÇAPI (Ø)	(AISI)	
ÖZLHV00008	230V	1500 W	8,5	304	A:200 B:250



HELEZON REZİSTANSI

HELIX HEATER

ÜRÜN KODU	VOLT	WATT	BORU		ÖLÇÜ / MM
			ÇAPI (Ø)	(AISI)	
ÖZLHV00009	230V	4000 W	8,5	304	A:485 B:300



M TİPİ SERPANTİNLİ REZİSTANS BEKOR: M 12 N TYPE SERPANTINE HEATERS BEKOR: M 12

ÜRÜN KODU	VOLT	WATT	BORU		ÖLÇÜ / MM
			ÇAPI (Ø)	(AISI)	
ÖZLHV00010	230V	UYGUN	8,5	304	A:300 B:200
ÖZLHV00011	230V	UYGUN	8,5	304	A:350 B:200
ÖZLHV00012	230V	UYGUN	8,5	304	A:400 B:200
ÖZLHV00013	230V	UYGUN	8,5	304	A:450 B:200
ÖZLHV00014	230V	UYGUN	8,5	304	A:500 B:200



M TİPİ SERPANTİNLİ REZİSTANSLAR REKOR: M 18 # TYPE SERPENTINE HEATERS RECORD: M 18

ÜRÜN KODU	VOLT	WATT	BORU ÇAP (Ø)	(AISI)	ÖLÇÜ / MM
ÖZLHV00015	230V	UYGUN	11,5	304	A:300 B:200
ÖZLHV00016	230V	UYGUN	11,5	304	A:350 B:200
ÖZLHV00017	230V	UYGUN	11,5	304	A:400 B:200
ÖZLHV00018	230V	UYGUN	11,5	304	A:450 B:200
ÖZLHV00019	230V	UYGUN	11,5	304	A:500 B:200



SERPANTİNLİ REZİSTANSLAR SERPENTINE HEATERS

ÜRÜN KODU	VOLT	WATT	BORU ÇAP (Ø)	(AISI)	ÖLÇÜ / MM
ÖZLHV00020	230V	1000 W	8,5	304	A:500 B:65



SOMUNLU SERPANTİNLİ REZİSTANSLAR REKOR: M 18 NUT SERPENTINE HEATERS RECORD: M 18

ÜRÜN KODU	VOLT	WATT	BORU ÇAP (Ø)	(AISI)	ÖLÇÜ / MM
ÖZLHV00021	230V	500 W - 3000 W	8,5	304	A:300,..... 1000



DİKOĞRUTGEN SERPANTİNLİ REZİSTANSLAR REKOR: M 12 RECTANGULAR SERPENTINE HEATERS RECORD: M 12

ÜRÜN KODU	VOLT	WATT	BORU ÇAP (Ø)	(AISI)	ÖLÇÜ / MM
ÖZLHV00022	230V	1500 W	8,5	304	A:553 B:22,5

FİŞEK REZİSTANSLAR**CARTRIDGE HEATERS**

Fişek Tip Rezistanslar endüstriyel alanlarda sıkça tercih edilen rezistans çeşitlerindedir. Kauçuk ve plastik işleme, gıda, kimya, ahşap ve daha pek çok farklı alanda sıkça kullanılan fişek rezistanslar, son zamanlarda tercih edilen ürünler arasındadır.

Cartridge Type Heaters are among the types of heater frequently preferred in industrial areas. Firecracker heater, which are frequently used in rubber and plastic processing, food, chemistry, wood and many other fields, are among the frequently preferred products recently.

**DİRSEKLİ FİŞEK REZİSTANS**
ELBOWED CARTRIDGE HEATER**KÜPLÜ FİŞEK REZİSTANS**
CUPED CARTRIDGE HEATER**REKORLU FİŞEK REZİSTANS**
RECOFD CARTRIDGE HEATER**BAKIR FİŞEK REZİSTANS**
COPPER CARTRIDGE HEATER**ÖZEL ÜRETİM FİŞEK REZİSTANS**
SPECIAL CARTRIDGE HEATER**ÖZEL ÜRETİM FİŞEK REZİSTANS**
SPECIAL CARTRIDGE HEATER

NOT: İSTENİLEN HER ÖLÇÜDE ÜRETİM YAPILABİLMEKTEDİR.

NOTE: PRODUCTION CAN BE MADE IN DESIRED SIZE.



SPIRAL REZİSTANSLAR

SPIRAL HEATERS

Spiral Rezistanslar, plastik sıcak yolluk sistemlerinde mamedeki hammaddenin akışkanlığını sağlamak amacı ile kullanılmaktadır. Spiral Rezistanslar, paketeleme endüstrisinde ve endüstriyel sektörlerin enjeksiyon makinelerinde, plastik hammaddeyi enjekte edilebilir sıcaklığa çıkarma için sıkça kullanılmaktadır. Sıcak Yolluk Rezistanslar değişik çapta içinden likit ya da gaz geçen boru hatlarının ısıtılmasında ve çeşitli projelerde kullanılmaktadır.

Spiral Heaters, are used in plastic hot runner systems to ensure the fluidity of the raw material in the nozzle. Spiral Heaters are frequently used in the packaging industry and in the injection machines of industrial sectors to raise the plastic raw material to injectable temperature. Hot Runner Heaters are used in heating pipelines passing liquid or gas of different diameters and in various projects.



KILIFLI SPIRAL REZİSTANS
SHEATHED SPIRAL HEATER



SPIRAL REZİSTANS
SPIRAL HEATER



SPIRAL REZİSTANS
SPIRAL HEATER



SPIRAL REZİSTANS
SPIRAL HEATER



SPIRAL REZİSTANSLAR
SPIRAL HEATERS



ÖZEL ÜRETİM KILIFLI SPIRAL REZİSTANS
SPECIAL SHEATHED SPIRAL HEATER

NOT: İSTENİLEN HER ÖLÇÜDE ÜRETİM YAPILABİLMEKTEDİR.

NOTE: PRODUCTION CAN BE MADE IN DESIRED SIZE.

KELEPÇE REZİSTANSLAR

CLAMP HEATERS

Kelepçe Rezistanslar; yüksek ısı derecesine sahip ortamlarda kullanılabilen rezistanstır. Farklı çalışma alanlarında sıkça kullanılan Bu rezistanslar 800° kadar yüksek dayanıklılık gösterilen ürünlerdir.

Kelepçe Tip Rezistans ürünlerimiz, alüminize çelik ya da özel galvanizden üretilmektedir. Genleşme ve esneme sorunlarına karşı da son derece dayanıklıdır. Kelepçe Rezistans modelleri dayanıklı yapısı sayesinde genellikle ağır sanayi endüstrisinde tercih edilmektedir. Ceniş bir kullanım alanına sahip olan kelepçe rezistanslar işlevsel özelliklerine göre farklı şekil ve modellerde üretilebilmektedir.

Clamp Heaters; It is resistance that can be used in environments with high temperatures. These resistors, which are frequently used in different workplaces, are products with high durability up to 800°.

Our Clamp Type Heaters products are produced from aluminian steel or special galvanized. It is also extremely resistant to expansion and yawning problems. Clamp Heaters models are generally preferred in the heavy industry thanks to their durable structure. Clamped Heaters, which have a wide range of uses, can be produced in different shapes and models according to their functional characteristics.



MIKA KELEPÇE REZİSTANS
MICA CLAMP HEATER



SERAMİK KELEPÇE REZİSTANS
CERAMIC CLAMP HEATER

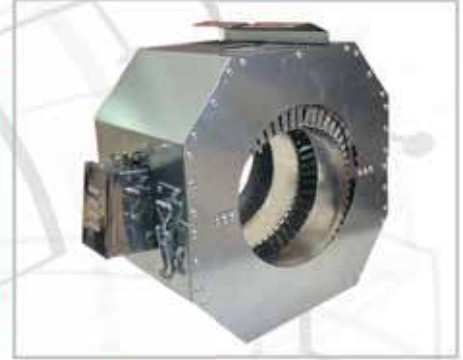

HAVA SOĞUTMALI KABİN REZİSTANS
AIR COOLED CABIN HEATER



MIKA KELEPÇE REZİSTANS
MICA CLAMP HEATER



MIKA KELEPÇE REZİSTANS
MICA CLAMP HEATER



SERAMİK KELEPÇE REZİSTANS
CERAMIC CLAMP HEATER

NOT: İSTENİLEN HER ÖLÇÜDE ÜRETİM YAPILABİLMEKTEDİR.

NOTE: PRODUCTION CAN BE MADE IN DESIRED SIZE.

MEME REZİSTANSLAR

NOZZLE HEATERS

Meme Rezistanslar, manifold ana giriş memesinin ve ana giriş memesinin ısıtılmasında sağlayan rezistans çeşididir. Bu rezistans tipleri, 80/20 1100°C krom-nikel tel, yüksek saflıkta mika, naturel mika, pirinç profil veya paslanmaz profilden imal edilir. M5 paslanmaz impus vida ve özel somun kullanılır.

Nozzle Heaters, are a type of heater that provides heating of the manifold main inlet nozzle and the main inlet nozzle. These resistance types are manufactured from 80/20 1100°C chrome-nickel wire, high purity mica, natural mica, brass profile or stainless profile. M5 stainless impus screw and special nut are used.



GALVANİZ MEME REZİSTANS
GALVANIZED NOZZLE HEATER



PASLANMAZ MEME REZİSTANS
STAINLESS NOZZLE HEATER



PASLANMAZ MEME REZİSTANS
STAINLESS NOZZLE HEATER



PIRİNÇ MEME REZİSTANS
BRASS NOZZLE HEATER



PIRİNÇ MEME REZİSTANS
BRASS NOZZLE HEATER



PIRİNÇ MEME REZİSTANS
BRASS NOZZLE HEATER

NOT: İSTENİLEN HER ÖLÇÜDE ÜRETİM YAPILABİLMEKTEDİR.

NOTE: PRODUCTION CAN BE MADE IN DESIRED SIZE.

PLAKA REZİSTANSLAR**MICA HEATERS**

Plaka Rezistanslar, kalıpların preslerin ısıtılmasında sıkça kullanılmakta olup ağırlıklı olarak plastik, kauçuk ve ambalaj sektöründe çokça tercih edilen bir rezistans türüdür.

Endüstride ısı sistemlerinde (otomotiv-yan sanayi, kauçuk kesim kalıpları, tekstil makineleri, ce enjeksiyon makinalarında) oluşabilecek sorunlara rahatlıkla cevap verebilen Plaka Tip Rezistanslar, yüksek verimli 80/20 krom nikel teleden paslanmaz ve bakır levhadan en son teknoloji ile özel olarak üretilen rezistanslardır.

Mica heaters are frequently used in heating molds and presses and are a type of resistance that is mostly preferred in the plastic, rubber and packaging industries.

Mica type heater, which can easily respond to problems that may occur in heat systems in the industry (automotive-sub-industry, rubber cutting moulds, textile machines, CE injection machines), are specially produced with the latest technology from high-efficiency 80/20 chrome-nickel wire, stainless steel and copper plate.

**PLAKA REZİSTANS
MICA HEATER****PLAKA REZİSTANS
MICA HEATER****PLAKA REZİSTANS
MICA HEATER****DISK PLAKA REZİSTANS
DISK MICA HEATER****PLAKA KENAR REZİSTANS
MICA EDGE HEATER****MİKA PLAKA REZİSTANS
MICA PLATE HEATER**

NOT: İSTENİLEN HER ÖLÇÜDE ÜRETİM YAPILABİLMEKTEDİR.

NOTE: PRODUCTION CAN BE MADE IN DESIRED SIZE.

FLANŞLI VE EXPROOF REZİSTANSLAR

FLANGED AND EXPROOF HEATERS

Flanşlı rezistanslar, borular, tanklar, kazanlar ve benzeri endüstriyel ekipmanlarda sıvıların veya gazların ısınmasını veya buharlaşmasını sağlamak için kullanılır. Genellikle metal ya da paslanmaz flanşa sahiptirler, bu sayede ekipmana kolayca monte edilebilirler.

Ex-proof rezistanslar, patlama riski yüksek ortamlarda kullanılmak üzere tasarlanmıştır. Kimya, petrokimya, petrol ve gaz endüstrileri gibi tehlikeli ortamlarda yaygın olarak kullanılır.

Flanged heaters are used to provide heating or vaporization of liquids or gases in pipes, tanks, boilers and similar industrial equipment. They usually have a metal or stainless flange so that they can be easily mounted on the equipment.

Ex-proof heaters are designed for use in environments with a high risk of explosion. They are widely used in hazardous environments such as chemical, petrochemical, oil and gas industries.



FLANŞLI VE EXPROOF REZİSTANSLAR
FLANGED AND EXPROOF HEATERS



FLANŞLI VE EXPROOF REZİSTANSLAR
FLANGED AND EXPROOF HEATERS



FLANŞLI VE EXPROOF REZİSTANSLAR
FLANGED AND EXPROOF HEATERS



FLANŞLI VE EXPROOF REZİSTANSLAR
FLANGED AND EXPROOF HEATERS



FLANŞLI VE EXPROOF REZİSTANSLAR
FLANGED AND EXPROOF HEATERS



FLANŞLI VE EXPROOF REZİSTANSLAR
FLANGED AND EXPROOF HEATERS

NOT: İSTENİLEN HER ÖLÇÜDE ÜRETİM YAPILABİLMEKTEDİR.

NOTE: PRODUCTION CAN BE MADE IN DESIRED SIZE.

QUARTZ REZİSTANSLAR

QUARTZ HEATERS

Quartz Rezistanslar değişik çaplarda ve boylar da değişik kullanım amaçlarına uygun olarak üretilmektedir. Standart üretim çapları 8 -10 -16 -18 -23 -25 mm'dir. Standart üretim boyları ise Minimum 250 mm Maksimum 3500mm'dir. Quartz Rezistanslar Minimum 24 V ile Maksimum 500 V DC besleme gerilimleri arasında üretilmektedir. Talep edilen güç değişkenlik gösterse de Minimum 250W Maksimum 10000W arasında üretilmektedir.

Quartz heaters are produced in different diameters and lengths to suit different purposes. Standard production diameters are 8 -10 -16 -18 -23 -25 mm. Standard production lengths are minimum 250 mm and maximum 3500 mm. Quartz heaters can be produced between minimum 24 V and maximum 500 V DC supply voltages. Although the requested power varies, it can be produced between minimum 250W and maximum 10000W.



QUARTZ REZİSTANSLAR
QUARTZ HEATERS



QUARTZ REZİSTANSLAR
QUARTZ HEATERS



QUARTZ REZİSTANSLAR
QUARTZ HEATERS

BALON ISITICILAR

CHEMICAL BALLOON HEATERS

Balon Isıtıcılar, laboratuvar ortamını gerektiren kimya, tıp, ilaç, gıda, boya ve tekstil sektörlerinde kullanılmakta olup, Laboratuvarlarda değişik hacimlerdeki cam balonların içine konulan sıvıların ısıtma işlemlerini gerçekleştirirler. Cihazların ısı kontrolleri 50-400° arasında derecelendirilmiş elektronik termostatlar ile yapılır. Cihazın ısıtıcı rezistansları cam elyaf makoronun içine yerleştirilip örülmektedir, bu sayede cam balona yumuşak bir yuva oluşturulmaktadır. Cihazlar özel siparişe göre dijital termostat kontrollü olarak da üretilmektedir.

Balloon Heaters are used in the chemical, medical, pharmaceutical, food, dye and textile sectors that require a laboratory environment, and they heat the liquids placed in glass balloons of different volumes in laboratories. Temperature controls of the devices are made with electronic thermostats rated between 50-400°. The heating resistors of the device are placed inside the glass fiber sleeve and knitted, thus creating a soft nest for the glass balloon. Devices are also produced with digital thermostat control according to special orders.



BALON ISITICI
CHEMICAL BALLOON HEATER



NOT: İSTENİLEN HER ÖLÇÜDE ÜRETİM YAPILABİLMEKTEDİR.

NOTE: PRODUCTION CAN BE MADE IN DESIRED SIZE.



MANİFOLD REZİSTANSLAR MANIFOLD HEATERS

Manifold Rezistanslar, kalıp ve pres makinelerinde, ısıtma için kullanılan son teknoloji ürünlerden biri olmakta olup birçok farklı fonksiyonu kapsayan özelliklere sahiptir. Enjeksiyon kalıplarındaki sıcak sistemin dağıtım aracı olarak tanımlanan Manifold Isıtıcılar, çok yüksek ısı değerlerine ulaşabilen ürünlerdir.

Kare ve silindirik biçiminde tasarlanan bu ürünler, endüstriyel ihtiyaçları karşılamak üzere üretilmektedir.

Manifold Heaters are one of the latest technology products used for heating in mold and press machines and have features that cover many different functions. Manifold Heaters, defined as the distribution means of the hot system in injection molds, are products that can reach very high temperature values.

These products, designed in square and cylindrical shapes, are produced to meet industrial needs.



MANIFOLD REZİSTANS
MANIFOLD HEATER



MANIFOLD REZİSTANS
MANIFOLD HEATER



KARE MANIFOLD ÇUBUĞU REZİSTANSI
SQUARE MANIFOLD BAR HEATER



MANIFOLD REZİSTANS
MANIFOLD HEATER



MANIFOLD REZİSTANS
MANIFOLD HEATER



MANIFOLD REZİSTANS
MANIFOLD HEATER

6X6 KARE - 8X8 KARE - 10X10 KARE

NOT: İSTENİLEN TÜM YUVARLAK ÇEŞİTLER ÖZEL OLARAK ÜRETİLEBİLMEKTEDİR.

NOTE: ALL REQUESTED ROUND TYPES CAN BE SPECIALLY PRODUCED.

TERMOKUPL**THERMOCOUPLE**

Termokupliler, geniş bir sıcaklık aralığında güvenilir ve hassas sıcaklık ölçümleri yapabilme yeteneği nedeniyle birçok farklı endüstri ve uygulama alanında kullanılırlar. Endüstriyel Proses Kontrolü, enerji üretimi, gıda ve içecek sanayi, metalurji ve madencilik, laboratuvar uygulamaları ve ısıtma ve soğutma sistemlerinde kullanım alanlarından bazılarıdır.

Termokupliler, çok düşük sıcaklıklardan (-200°C) çok yüksek sıcaklıklara (2000°C ve daha fazlası) kadar geniş bir aralıkta çalışabilir.

Thermocouples are used in many different industries and applications due to their ability to provide reliable and precise temperature measurements over a wide temperature range. Some of the areas of use are Industrial Process Control, energy production, food and beverage industry, metallurgy and mining, laboratory applications and heating and cooling systems.

Thermocouples can operate over a wide range from very low temperatures (-200°C) to very high temperatures (2000°C and more).

**BAYONET TİP TERMOKUPL**
BAYONET TYPE THERMOCOUPLE**MANTEL TİP TERMOKUPL**
MENTAL TYPE THERMOCOUPLE**KAFALI TİP TERMOKUPL**
HEAD TYPE THERMOCOUPLE**M6-M8-M10 VİDALI TİP TERMOKUPL**
M6-M8-M10 SCREW TYPE THERMOCOUPLE**ÖZEL ÜRETİM PT100 TERMOKUPL**
SPECIAL PT100 THERMOCOUPLE**ÖZEL ÜRETİM TERMOKUPL**
SPECIAL PRODUCTION THERMOCOUPLE

NOT: İSTENİLEN HER ÖLÇÜDE ÜRETİM YAPILABİLMEKTEDİR.

NOTE: PRODUCTION CAN BE MADE IN DESIRED SIZE.

**SICAK YOLLUK PATLAMA ÇARPLARI
HOT RUNNER EXPLOSION MULTIPLE**

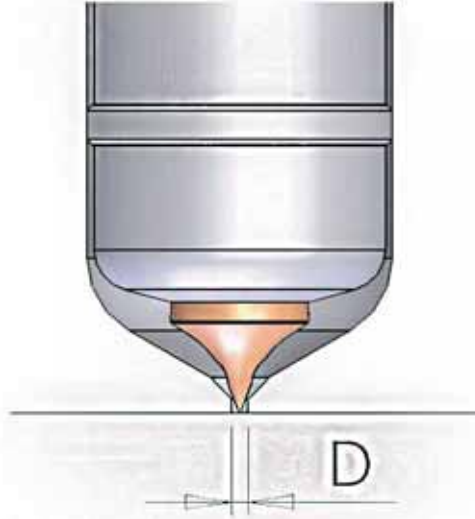

1- YUMUŞAK PLASTİKLER : PE - PP - PS

2- ORTA SERT PLASTİKLER : ABS - ASA - PANYLON - PETB - POM - SAN

3- SERT PLASTİKLER : CAB - PBTP - PC - PES - PMMA - PPO - PPS - PSU - TPU

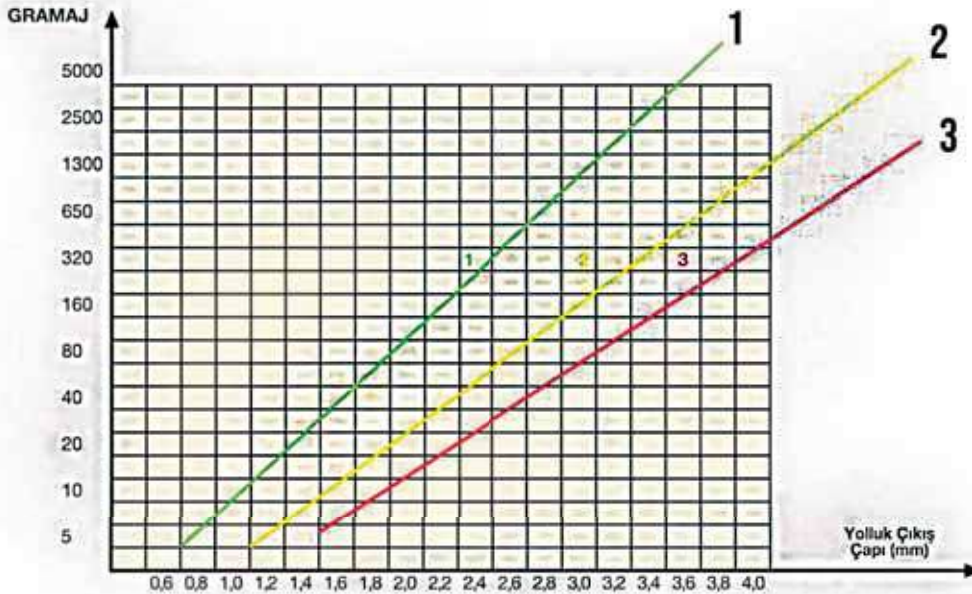

NOZZLE / SICAK YOLLUK MEMELERİ
NOZZLE / HOT RUNNER NOZZLES

QUICK SHOT VİDALI TİP SIVRI UÇ SICAK YOLLUK NOZZLE
 QUICK SHOT SCREW TYPE POINTED TIP HOT RUNNER NOZZLE

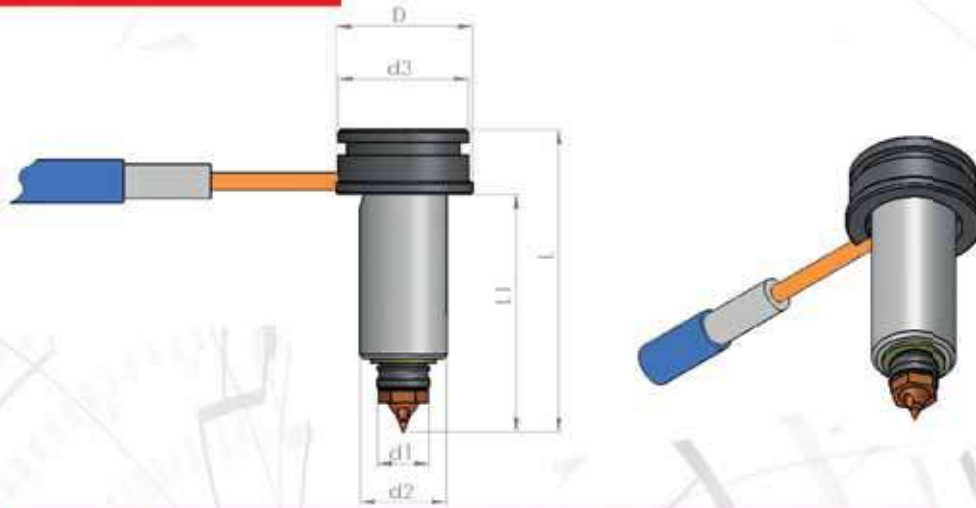

MEME TİPİ	d1	d2	d3	D	L1	L	REZİSTANS
ISR 20X50	12	20	30	32	35	50	12x22mm-180W
ISR 20X60	12	20	30	32	45	60	12x32mm-230W
ISR 20X70	12	20	30	32	55	70	12x42mm-300W
ISR 20X80	12	20	30	32	65	80	12x52mm-300W
ISR 20X90	12	20	30	32	75	90	12x62mm-350W
ISR 20X100	12	20	30	32	85	100	12x72mm-420W
ISR 23X50	15	25	32	34	35	50	15x22mm-180W
ISR 23X60	15	25	32	34	45	60	15x32mm-230W
ISR 23X70	15	25	32	34	55	70	15x42mm-300W
ISR 23X80	15	25	32	34	65	80	15x52mm-350W
ISR 23X90	15	25	32	34	75	90	15x62mm-420W
ISR 23X100	15	25	32	34	85	100	15x72mm-520W
ISR 28X60	20	28	38	42	45	60	20x32mm-300W
ISR 28X70	20	28	38	42	55	70	20x42mm-350W
ISR 28X80	20	28	38	42	65	80	20x52mm-420W
ISR 28X90	20	28	38	42	75	90	20x62mm-520W
ISR 28X100	20	28	38	42	85	100	20x72mm-620W
ISR 28X110	20	28	38	42	95	110	20x82mm-620W
ISR 28X120	20	28	38	42	105	120	20x92mm-700W
ISR 28X130	20	28	38	42	115	130	20x102mm-800W

NOT: ÖZEL ÖLÇÜLER İÇİN ÜRETİM YAPILABİLMEKTEDİR.

NOTE: PRODUCTION CAN BE MADE FOR SPECIAL SIZES.

NOZZLE / SICAK YOLLUK MEMELERİ

NOZZLE / HOT RUNNER NOZZLES

QUICK SHOT VİDALI TİP SIVRI UC SICAK YOLLUK NOZZLE YUVASI
QUICK SHOT SCREW TYPE POINTED TIP HOT RUNNER NOZZLE SLOT

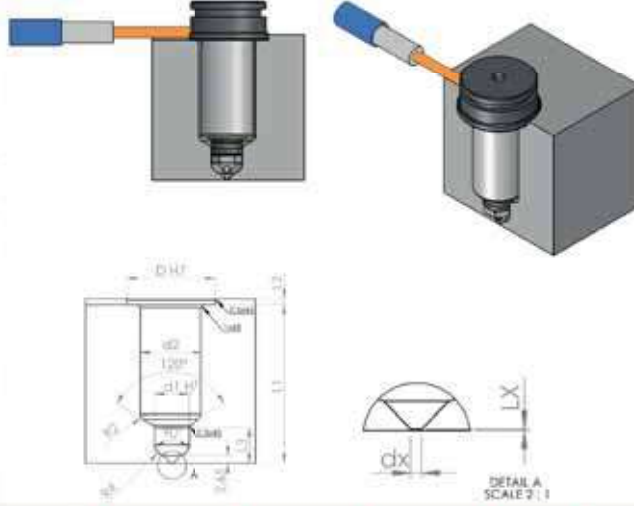

MEME TİPİ	D	d2	d1	L2	L1	L3	LX	dx
ISR 20X50	32	23	12	2	35	13	0.15	1
ISR 20X60	32	23	12	2	45	13	0.15	1
ISR 20X70	32	23	12	2	55	13	0.15	1
ISR 20X80	32	23	12	2	65	13	0.15	1
ISR 20X90	32	23	12	2	75	13	0.15	1
ISR 20X100	32	23	12	2	85	13	0.15	1
ISR 23X50	34	26	15	2	35	13	0.15	1
ISR 23X60	34	26	15	2	45	13	0.15	1
ISR 23X70	34	26	15	2	55	13	0.15	1
ISR 23X80	34	26	15	2	65	13	0.15	1
ISR 23X90	34	26	15	2	75	13	0.15	1
ISR 23X100	34	26	15	2	85	13	0.15	1
ISR 28X60	42	32	20	2	45	15	0.15	1
ISR 28X70	42	32	20	2	55	15	0.15	1
ISR 28X80	42	32	20	2	65	15	0.15	1
ISR 28X90	42	32	20	2	75	15	0.15	1
ISR 28X100	42	32	20	2	85	15	0.15	1
ISR 28X110	42	32	20	2	95	15	0.15	1
ISR 28X120	42	32	20	2	105	15	0.15	1
ISR 28X130	42	32	20	2	115	15	0.15	1

NOT: ÖZEL ÖLÇÜLER İÇİN ÜRETİM YAPILABİLMEKTEDİR.

NOTE: PRODUCTION CAN BE MADE FOR SPECIAL SIZES.

NOZZLE / SICAK YOLLUK MEMELERİ
NOZZLE / HOT RUNNER NOZZLES

QUICK SHOT VİDALI TİP DÜZ UÇ SICAK YOLLUK NOZZLE
 QUICK SHOT SCREW TYPE FLAT TIP HOT RUNNER NOZZLE

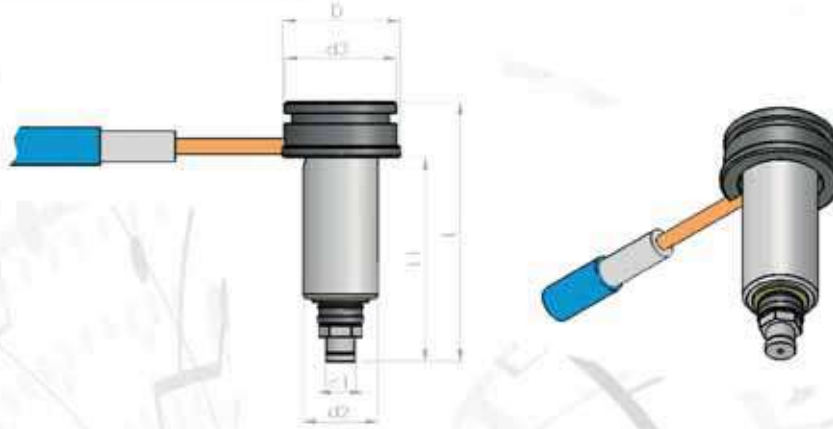

MEME TİPİ	d1	d2	d3	D	L1	L	REZİSTANS
ISR 20X50	8	20	30	32	35	50	12x22mm-180W
ISR 20X60	8	20	30	32	45	60	12x32mm-230W
ISR 20X70	8	20	30	32	55	70	12x42mm-300W
ISR 20X80	8	20	30	32	65	80	12x52mm-300W
ISR 20X90	8	20	30	32	75	90	12x62mm-350W
ISR 20X100	8	20	30	32	85	100	12x72mm-420W
ISR 23X50	10	25	32	34	35	50	15x22mm-180W
ISR 23X60	10	25	32	34	45	60	15x32mm-230W
ISR 23X70	10	25	32	34	55	70	15x42mm-300W
ISR 23X80	10	25	32	34	65	80	15x52mm-350W
ISR 23X90	10	25	32	34	75	90	15x62mm-420W
ISR 23X100	10	25	32	34	85	100	15x72mm-520W
ISR 28X60	14	28	38	42	45	60	20x32mm-300W
ISR 28X70	14	28	38	42	55	70	20x42mm-350W
ISR 28X80	14	28	38	42	65	80	20x52mm-420W
ISR 28X90	14	28	38	42	75	90	20x62mm-520W
ISR 28X100	14	28	38	42	85	100	20x72mm-620W
ISR 28X110	14	28	38	42	95	110	20x82mm-620W
ISR 28X120	14	28	38	42	105	120	20x92mm-700W
ISR 28X130	14	28	38	42	115	130	20x102mm-800W

NOT: ÖZEL ÖLÇÜLER İÇİN ÜRETİM YAPILABİLMEKTEDİR.

NOTE: PRODUCTION CAN BE MADE FOR SPECIAL SIZES.

NOZZLE / SICAK YOLLUK MEMELERİ

NOZZLE / HOT RUNNER NOZZLES

QUICK SHOT VİDALI TİP DÜZ UÇ SICAK YOLLUK NOZZLE YUVASI
QUICK SHOT SCREW TYPE FLAT TIP HOT RUNNER NOZZLE SLOT

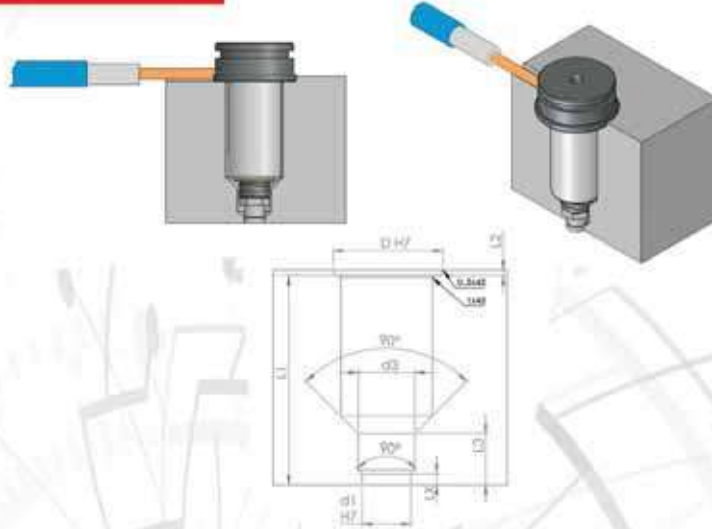

MEME TİPİ	D	d2	d3	d1	L2	L1	L3	LX
ISR 20X50	32	23	13	8	2	45	13	2
ISR 20X60	32	23	13	8	2	45	13	2
ISR 20X70	32	23	13	8	2	55	13	2
ISR 20X80	32	23	13	8	2	65	13	2
ISR 20X90	32	23	13	8	2	75	13	2
ISR 20X100	32	23	13	8	2	85	13	2
ISR 23X50	34	26	16	10	2	35	13	2
ISR 23X60	34	26	16	10	2	45	13	2
ISR 23X70	34	26	16	10	2	55	13	2
ISR 23X80	34	26	16	10	2	65	13	2
ISR 23X90	34	26	16	10	2	75	13	2
ISR 23X100	34	26	16	10	2	85	13	2
ISR 28X60	42	32	21	14	2	45	13	2
ISR 28X70	42	32	21	14	2	55	13	2
ISR 28X80	42	32	21	14	2	65	13	2
ISR 28X90	42	32	21	14	2	75	13	2
ISR 28X100	42	32	21	14	2	85	13	2
ISR 28X110	42	32	21	14	2	95	13	2
ISR 28X120	42	32	21	14	2	105	13	2
ISR 28X130	42	32	21	14	2	115	13	2

NOT: ÖZEL ÖLÇÜLER İÇİN ÜRETİM YAPILABİLMEKTEDİR.

NOTE: PRODUCTION CAN BE MADE FOR SPECIAL SIZES.

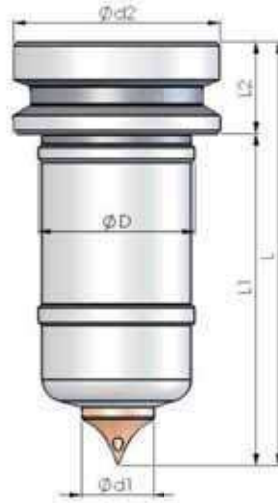
NOZZLE / SICAK YOLLUK MEMELERİ
NOZZLE / HOT RUNNER NOZZLES
**SİVRİ UÇ SICAK YOLLUK MEMELERİ
 POINTED TIP HOT RUNNER NOZZLES**

MEME TİPİ	D	d1	d2	L2	L1	L
ISR220046	22	10	29	13	46	59
ISR220056	22	10	29	13	56	69
ISR220066	22	10	29	13	66	79
ISR220076	22	10	29	13	76	89
ISR220086	22	10	29	13	86	99
ISR220096	22	10	29	13	96	109
ISR280046	28	12	34	13	46	59
ISR280056	28	12	34	13	56	69
ISR280066	28	12	34	13	66	79
ISR280076	28	12	34	13	76	89
ISR280086	28	12	34	13	86	99
ISR280096	28	12	34	13	96	109
ISR300046	30	14	39	13	46	59
ISR300056	30	14	39	13	56	69
ISR300066	30	14	39	13	66	79
ISR300076	30	14	39	13	76	89
ISR300086	30	14	39	13	86	99
ISR300096	30	14	39	13	96	109

NOT: ÖZEL ÖLÇÜLER İÇİN ÜRETİM YAPILABİLMEKTEDİR.

NOTE: PRODUCTION CAN BE MADE FOR SPECIAL SIZES.

**SIVRI UÇ SICAK YOLLUK MEMELERİ YUVA
POINTED TIP HOT RUNNER NOZZLES SLOT**

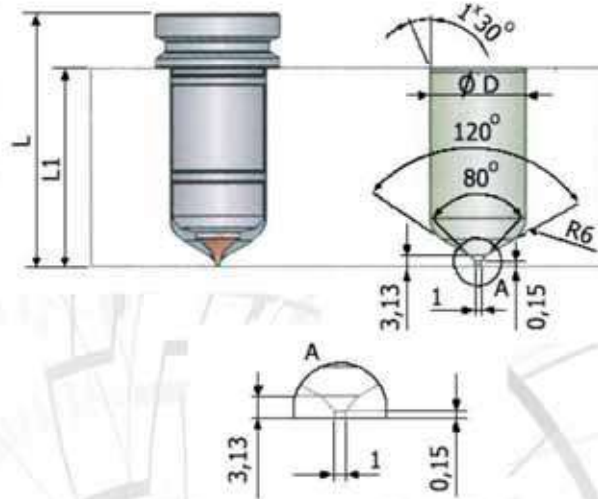

MEME TİPİ	D	L1	L
ISR220046	22 ^{+0,02}	46	59
ISR220056	22 ^{+0,02}	56	69
ISR220066	22 ^{+0,02}	66	79
ISR220076	22 ^{+0,02}	76	89
ISR220085	22 ^{+0,02}	86	99
ISR220096	22 ^{+0,02}	96	109
ISR280046	28 ^{+0,02}	46	59
ISR280056	28 ^{+0,02}	56	69
ISR280066	28 ^{+0,02}	66	79
ISR280076	28 ^{+0,02}	76	89
ISR280085	28 ^{+0,02}	86	99
ISR280096	28 ^{+0,02}	96	109
ISR300046	30 ^{+0,02}	46	59
ISR300056	30 ^{+0,02}	56	69
ISR300066	30 ^{+0,02}	66	79
ISR300076	30 ^{+0,02}	76	89
ISR300085	30 ^{+0,02}	86	99
ISR300096	30 ^{+0,02}	96	109

NOT: ÖZEL ÖLÇÜLER İÇİN ÜRETİM YAPILABİLMEKTEDİR.

NOTE: PRODUCTION CAN BE MADE FOR SPECIAL SIZES.

NOZZLE / SICAK YOLLUK MEMELERİ

NOZZLE / HOT RUNNER NOZZLES

**DÜZ UÇ SICAK YOLLUK MEMELERİ
STRAIGHT END HOT RUNNER NOZZLES**

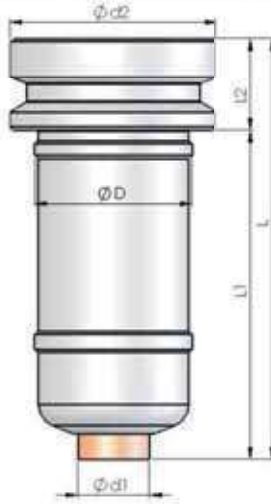

MEME TİPİ	D	d1	d2	L2	L1	L
ISR220046	22	10	29	13	46	59
ISR220056	22	10	29	13	56	69
ISR220066	22	10	29	13	66	79
ISR220076	22	10	29	13	76	89
ISR220086	22	10	29	13	86	99
ISR220096	22	10	29	13	96	109
ISR280046	28	12	34	13	46	59
ISR280056	28	12	34	13	56	69
ISR280066	28	12	34	13	66	79
ISR280076	28	12	34	13	76	89
ISR280086	28	12	34	13	86	99
ISR280096	28	12	34	13	96	109
ISR300046	30	14	39	13	46	59
ISR300056	30	14	39	13	56	69
ISR300066	30	14	39	13	66	79
ISR300076	30	14	39	13	76	89
ISR300086	30	14	39	13	86	99
ISR300096	30	14	39	13	96	109

NOT: ÖZEL ÖLÇÜLER İÇİN ÜRETİM YAPILABİLMEKTEDİR.

NOTE: PRODUCTION CAN BE MADE FOR SPECIAL SIZES.

DÜZ UÇ SICAK YOLLUK MEMELERİ YUVA
STRAIGHT END HOT RUNNER NOZZLES NEST

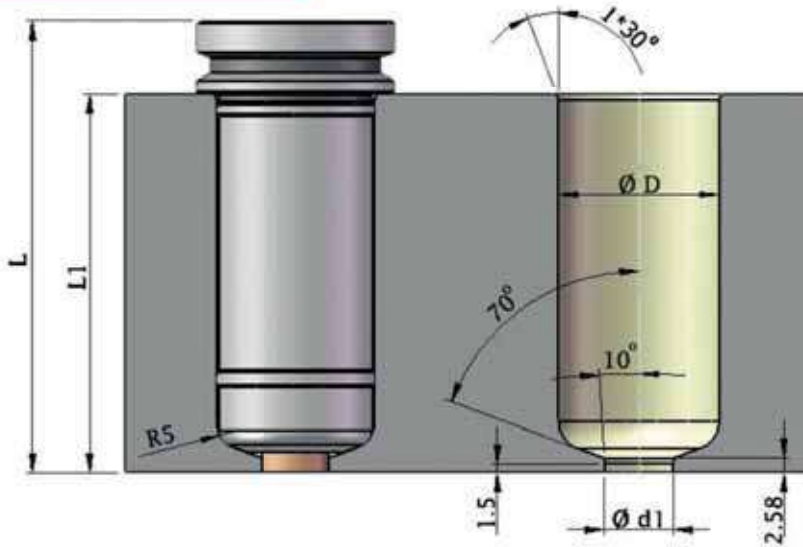

MEME TİPİ	D	d1	L1	L
ISR220046	22 ^{+0.02}	10	46	59
ISR220056	22 ^{+0.02}	10	56	69
ISR220066	22 ^{+0.02}	10	66	79
ISR220076	22 ^{+0.02}	10	76	89
ISR220086	22 ^{+0.02}	10	86	99
ISR220096	22 ^{+0.02}	10	96	109
ISR280046	28 ^{+0.02}	12	46	59
ISR280056	28 ^{+0.02}	12	56	69
ISR280066	28 ^{+0.02}	12	66	79
ISR280076	28 ^{+0.02}	12	76	89
ISR280086	28 ^{+0.02}	12	86	99
ISR280096	28 ^{+0.02}	12	96	109
ISR300046	30 ^{+0.02}	14	46	59
ISR300056	30 ^{+0.02}	14	56	69
ISR300066	30 ^{+0.02}	14	66	79
ISR300076	30 ^{+0.02}	14	76	89
ISR300086	30 ^{+0.02}	14	86	99
ISR300096	30 ^{+0.02}	14	96	109

NOT: ÖZEL ÖLÇÜLER İÇİN ÜRETİM YAPILABİLMEKTEDİR.

NOTE: PRODUCTION CAN BE MADE FOR SPECIAL SIZES.

SICAK YOLLUK KONTROL ÜNİTESİ

HOT RUNNER CONTROL UNIT

Sıcak yolluk kontrol ünitesi cihazları hedef noktanın ısısını algılayabilen bir sensör sinyalini bir ayar noktası ile karşılaştırarak ve bu değerler arasındaki sapmaya göre hesaplamalar yaparak bir ısıtıcıyı veya başka bir ekipmanı kontrol etmek için kullanılmaktadır.

Sıcak yolluk kontrol ünitesi cihazları , çok ve tek gözlü sıcak yolluklu kalıpların ısı kontrol sistemidir. Tek modülden ihtiyaç sayısına kadar ısı kontrol cihazı hazırlanabilmekte olup SSR, sigorta ve ara kablo gibi elemanları ile tamamlanmış çalıştırılmaya hazır modüllerdir.

Hot runner control unit devices are used to control a heater or other equipment by comparing a sensor signal that can detect the temperature of the target point with a set point and making calculations based on the deviation between these values.

Hot runner control unit devices are the heat control system of multi-cavity and single-cavity hot runner molds. Heat control devices can be prepared from a single module to the required number, and they are ready-to-operate modules complete with elements such as SSR, fuse and connecting cable.



2 GÖZLÜ SICAK YOLLUK KONTROL ÜNİTESİ
2 WAY HOT RUNNER CONTROL UNIT



5 GÖZLÜ SICAK YOLLUK KONTROL ÜNİTESİ
5 WAY HOT RUNNER CONTROL UNIT



10 GÖZLÜ SICAK YOLLUK KONTROL ÜNİTESİ
10 WAY HOT RUNNER CONTROL UNIT



6 GÖZLÜ SICAK YOLLUK KONTROL ÜNİTESİ
6 WAY HOT RUNNER CONTROL UNIT



24 GÖZLÜ SICAK YOLLUK KONTROL ÜNİTESİ
24 WAY HOT RUNNER CONTROL UNIT



SICAK YOLLUK KONTROL ÜNİTESİ
HOT RUNNER CONTROL UNIT

NOT: 1 - 2 - 3 - 4 - 5 - 6 - 7 - 8 - 9 - 10 - 11 - 12 GÖZLÜ STANDART CİHAZ ÜRETİMİMİZ BULUNMAKTADIR. ÖZEL ÜRETİMİMİZ BULUNMAKTADIR.

NOTE: WE PRODUCE STANDARD DEVICES WITH 1 - 2 - 3 - 4 - 5 - 6 - 7 - 8 - 9 - 10 - 11 - 12 MEDIUMS. WE HAVE SPECIAL PRODUCTION.

ISIER

REZİSTANS



Telefon :
+90 212 640 87 58



E-Mail
info@isierrezistans.com



WhatsApp:
+90 543 107 34 58



MERKEZ

İkitelli Osb. Mah
Saraçlar Sanayi Sitesi 1.Blok No:14
Başakşehir - İSTANBUL



BAYRAMPAŞA ŞUBE

Rami Kışla Cad. Üretmen İş Merkezi
A Blok No: 211 Eyüpsultan/İstanbul



FABRİKA

Merkez, İbrahim Tekinok Cad.
No:46 \A Şenpazar/Kastamonu

Yüksek Kalite

Üstün Mühendislik

Seri Üretim



/isierrezistans

www.isierrezistans.com



ARS Dijital Medya ve Pazarlama Ajansı
www.arsdijital.com